

artist of light

Specification

For LED Neon Flex Ribbon

C-SFR-F15S-DMX



CLEAR
LIGHTING

Table of Contents

Introduction	03
1. Specifications & Parameters	04
1.1 Dimensions of Light	
1.2 Technical Parameters	
1.3 Optical Parameters	
2. Functions & Features	05
2.1 Product Features	
2.2 Minimum Bend Diameter	
3. Types of Connector	05
3.1 Injection-Moulded Connector	
3.2 Anti-wicking Ferrule	
3.3 Male & Female Connector	
4. Compatible Control System	08
4.1 LT-800	
4.2 LT-600	
5. Mounting Profile	09
5.1 Plastic Profile	
5.2 Spring Clip Aluminum Profile	
5.3 Cable Exit Oriented Aluminum Profile	
(Applicable to Injection-moulded Connector Only)	
5.4 Corner Aluminum Profile	
(Applicable to Injection-moulded Connector Only)	
5.5 Bendable Stainless Steel Profile	
5.6 Recessed Mounting Profile	
6. Packaging	12
7. Appendix	13
7.1 Product Naming Convention	
7.2 Certificate	
7.3 Third-Party Test Report	
7.4 Reliability Test of Light	
7.5 (X,Y) Chromaticity Diagram	
7.6 Wavelength of Color Light	
7.7 Loading Chart	
7.8 Correlated Color Temperature	

Introduction

C-SFR-F15S(DMX512) is a member of the Artist of Light series embodied all the benefits of F15A/E with the addition of DMX512 addressable technology, generating advanced chasing and programmable scenes and complete animated visual effects.

C-SFR-F15S(DMX512) is UL/cUL, CE, and RoHS compliant. Moreover, it has passed rigorous environmental resistance, optical, mechanical and electrical tests in our lab under the support of advanced experimental equipments and technology to ensure it meets the requirements of harsh environments. Also it has passed relevant tests of third party inspection authority.

Fully encapsulated in the flexible silicone chamber by utilizing consummate extrusion technology, assembled with multiple patented connectors to achieve IP67 protection, easy for installation and applicable for various circumstances.

C-SFR-F15S(DMX512) features the capability of producing millions of colors and impressive animated effects when paired with DMX512 controller, also ultra flexibility and pliability with small bend diameter in curve bending shape.

Applications:

1. Outdoor or Indoor Contour/Border Lighting
2. Architectural Outline/Decorative Lighting
3. Cove/Accent Lighting
4. Facade/Floor Lighting
5. Signage/Guide Lighting

1. Specifications & Parameters

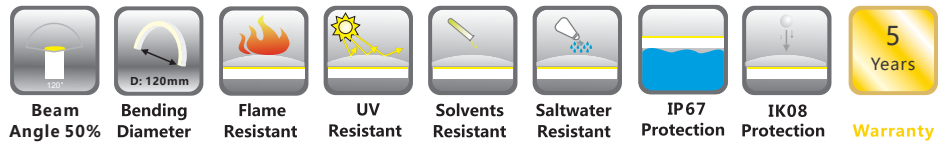

1.1 Dimensions of Light

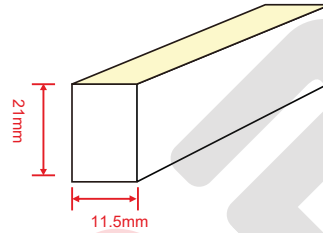
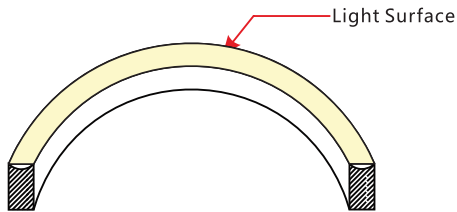

Note: Unless otherwise specified, the tolerance of the dimensions is $\pm 0.3\text{mm}$.

1.2 Technical Parameters

Technical Parameters

Article No.	C-SFR-F15S6-24CC-DMX	C-SFR-F15S6-24CC-DMX
Color	RGB	RGBW(2700K/4000K)
IC Type	DMX512CN	DMX512CN
Working Voltage	DC24V	DC24V
Rated Power/m	12W	15W
LED Qty/m	60	60
LED Distance	16.67mm	16.67mm
Min. Cutting Unit	10LEDs (1 pixel)	10LEDs (1 pixel)
Min. Cutting Length	166.7mm (1unit)	166.7mm (1unit)
Continuous Length	20m (Dynamic Operating) 15m (Static Full Loading)	15m (Dynamic Operating) 10m (Static Full Loading)
Package Length	$\leq 20\text{m}$	
Weight/m	325g	
Storage Temperature	$-40 \sim 60^\circ\text{C}$	
Ambient Working Temperature	$-40 \sim 55^\circ\text{C}$	
Ambient Installation Temperature	$-40 \sim 50^\circ\text{C}$	
IP Rating	IP67/IP40	

Note: For this product that over 12W per meter, full loading operating is not recommended.

1.3 Optical Parameters

Photometric Data

Article No.	C-SFR-F15S6-24CC(RGB/RGBW)	
LED Type	SMD	
Beam Angle 50%	120°	
Color	Wavelength&CCT	Lumen
Red	618-624nm	>30lm
Green	522-528nm	>75lm
Blue	468-474nm	>15lm
RGB	R+G+B	>120lm
2700K	2725 \pm 145K	>80lm
4000K	3985 \pm 275K	>80lm

Candle power distribution

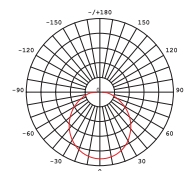

Illuminance Characteristics

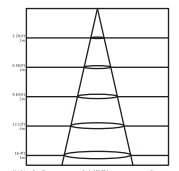

2. Functions & Features

2.1 Product Features

1. High quality SMD LED & IC Chip.
2. DMX512CN IC, DMX512 signal input, DMX address writable or programable.
3. UV & flame resistant construction(silicone).
4. Extremely flat profile and flush light surface.
5. High color consistency&smooth illumination with invisible light dots.
6. Flexible with 120mm minimum bending diameter.
7. Easy installation and assembly with DIY accessories for joining and terminating.
8. High IP rating(IP67).
9. The product IP rate is ultimately in line with properly applied IP rated connectors.
10. Environmentally friendly & energy efficient.
11. Automated production, high reliability & long warranty.
12. 5 years life span.

2.2 Minimum Bend Diameter

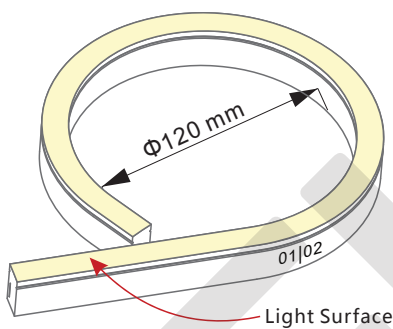

The light can only be bent laterally (opposite bend along to light surface).

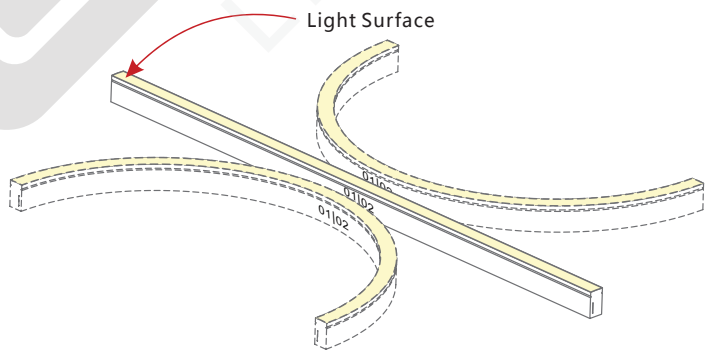

Do not bend smaller than allowed minimum bend diameter.

3. Types of Connector

3.1 Injection-moulded Connector

Note:

1. Unless otherwise stated, the tolerance of the connector is $\pm 0.5\text{mm}$;
2. Continuous length up to 10/15/20m by powering one end.

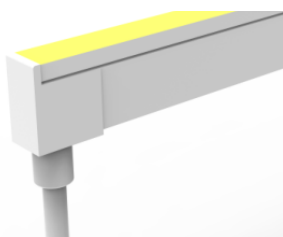

Injection-moulded Front Connector (bottom)

Connects light to power supply with pre-installed bottom feed cable, IP67. Cable length available in 0.3m, 1m, 3m, 5m, 10m.

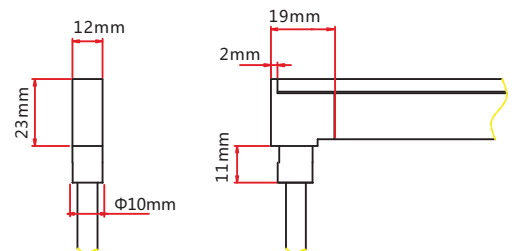

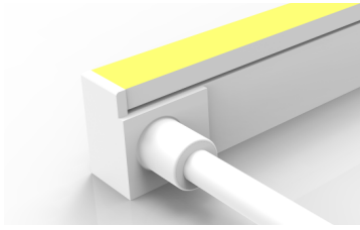

Injection-moulded Front Connector (side)

Connects light to power supply with pre-installed side feed cable, IP67. Cable length available in 0.3m, 1m, 3m, 5m, 10m.

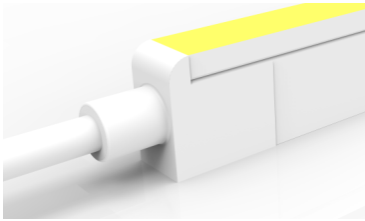
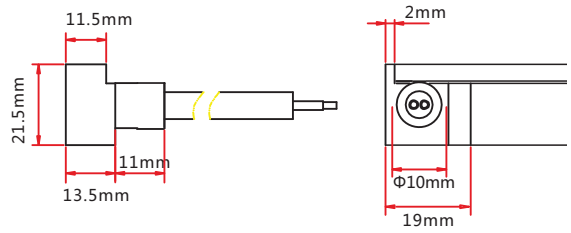

Injection-moulded Front Connector (top end)

Connects light to power supply with pre-installed end feed cable, IP67. Cable length available in 0.3m, 1m, 3m, 5m, 10m.

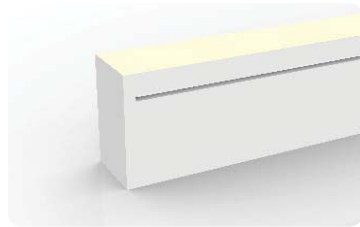
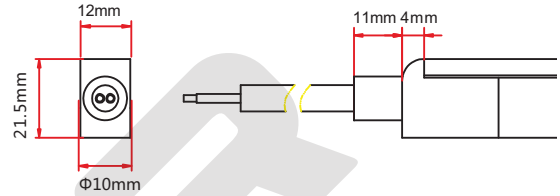

Injection-moulded End Cap

Pre-installed termination protection of the light, IP67.

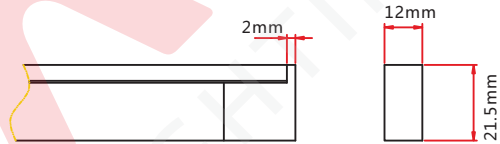

Injection-moulded Jumper

Connects two pieces of lights together with a flexible cable. IP67 Injection-moulded connector. L available in 0.3~1m.

Maximum 8 Jumpers in 20m
Maximum 4 Jumpers in 10m

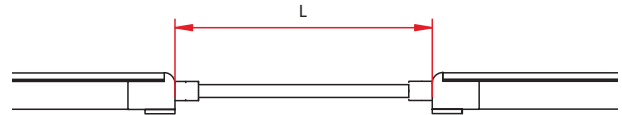

Injection-moulded T-feed

Connects two pieces of lights together with a T joint, energized from middle. IP67 Injection-moulded connector. L1 and L2 available in 0.15~0.5m. L3 available in 0.3-3m.

Maximum 8 T-feeds in 20m
Maximum 4 T-feeds in 10m

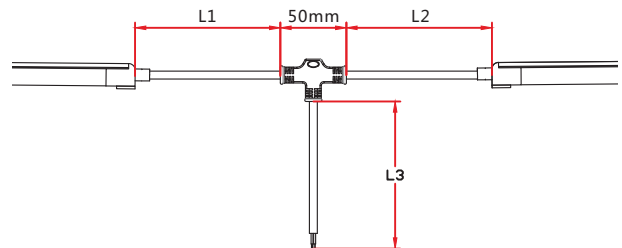

3.2 Anti-wicking Ferrule

Note: Unless otherwise stated, the tolerance is $\pm 0.5\text{mm}$.

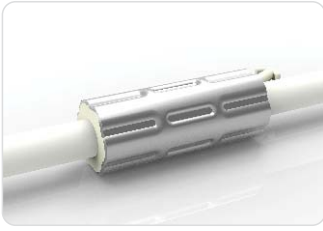

Anti-wicking Ferrule

The anti-wicking ferrule is located at 115mm ($\pm 5\text{mm}$ tolerance) from the connector on the cable.

For protection against water ingress from inside of cable wire and hence damage the light.

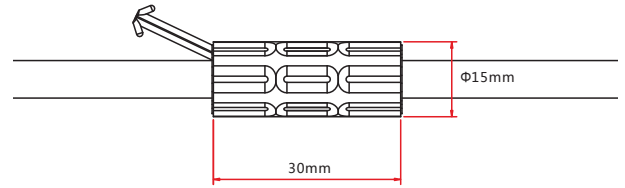

3.3 Male & Female Connector

Note: Unless otherwise stated, the tolerance is $\pm 2\text{mm}$.



Male & female Connector

For plug and play cable junction, DIY or Pre-installed connector, IP68

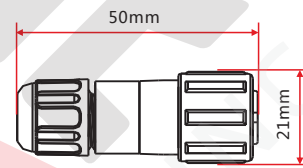

4. Compatible DMX Control System (Recommended)

4.1 LT-800

LT-800



1. LT-800 DMX512 controller works .
2. Each LT-800 DMX512 controller can control max.

Suitable for relatively large projects; each decoder can control max. 15m lights.

4.2 LT-600 Unit



1. Offline SD card store request programme. Ethernet real time computer control via synchronous display.
2. DMX 512 and SPI signal outputs are optional; can be connected with DMX console to form lighting control network.
3. Extra large control capability, 16 channels signal output, max. control 30720 pixels.

Suitable for large projects; each channel can control max. 120m lights, each LT-600 can control around 1600m lights.

Note:

The Pixel Addressable Light series allows precise control of every cutting increment. To ensure IC chips receive strong control signals, please adhere to the parameters listed below.

- 1) To ensure strong signal the 3-wire signal cable should not exceed 10m.
- 2) For cable lengths longer than 10m, a signal amplifier must be used for strong signal transmission. Please ask our technical team for more details.

5. Mounting Profile

5.1 Plastic Profile

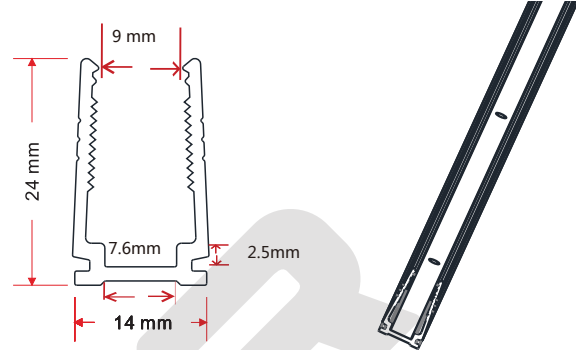
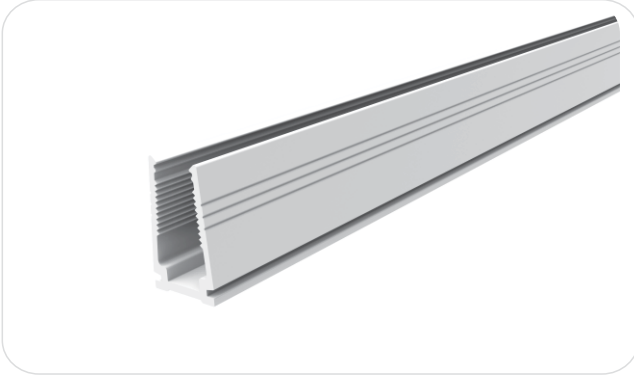

Note: Unless otherwise stated, the tolerance of the profile is $\pm 0.5\text{mm}$.

Installation Way

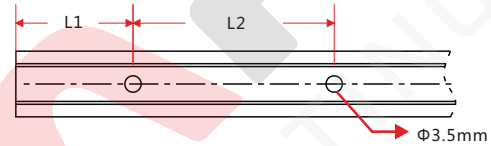

Model	W*H(mm)	Standard Length (mm)	L1 (mm)	L2 (mm)	Screw Hole (mm)	Hole Number
F15-PC/PL	14*24	500	50	200	$\Phi 3.5$	3
		1000	100	200	$\Phi 3.5$	5
		2000	100	200	$\Phi 3.5$	10

5.2 Spring Clip Aluminum Profile

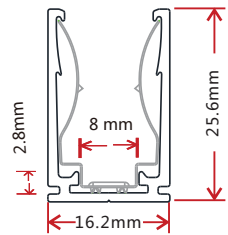
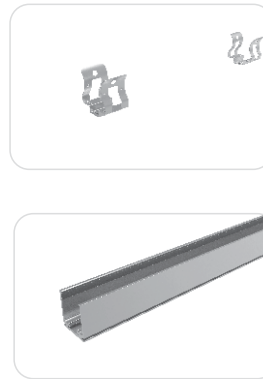

Note: Unless otherwise stated, the tolerance of the profile is $\pm 0.5\text{mm}$.

Installation Way

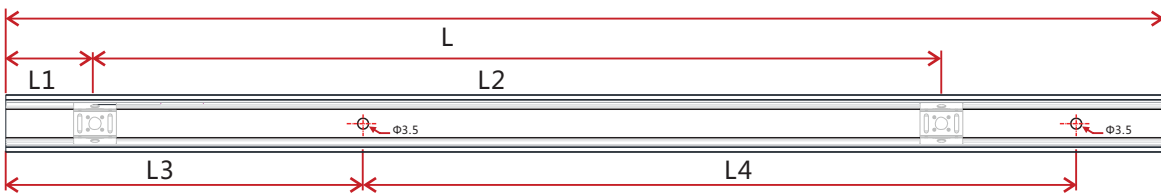

Model	W*H(mm)	Standard Length(mm)	L1(mm)	L2(mm)	L3(mm)	L4(mm)	Hole Screw(mm)	Hole Number	Clip Number
F15-SCA/PL	16.2*25.6	35	17.5	/	5	25	$\Phi 3.5$	2	1
		500	25	225	50	200	$\Phi 3.5$	3	3
		1000	25	237.5	100	200	$\Phi 3.5$	5	5
		2000	25	243.8	100	200	$\Phi 3.5$	10	9

5.3 Cable Exit Oriented Aluminum Profile (Applicable to Injection-moulded Connector Only)

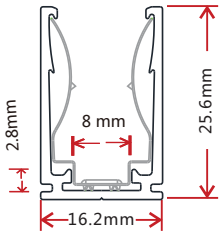

Note: Unless otherwise stated, the tolerance of the profile is $\pm 0.5\text{mm}$.

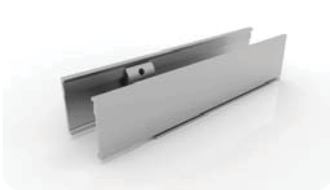

Bottom Feed



Middle Feed

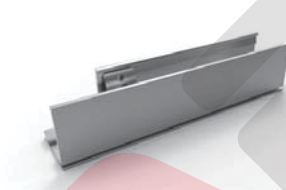

Side Feed From Left

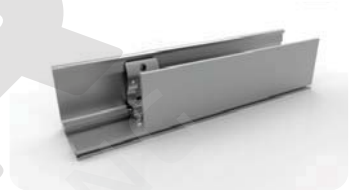

Side Feed From Right

5.4 Corner Aluminum Profile (Applicable to Injection-moulded Connector Only)

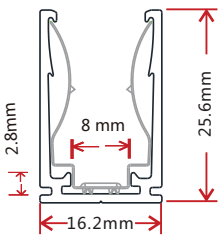

Note: Unless otherwise stated, the tolerance of the profile is $\pm 0.5\text{mm}$.

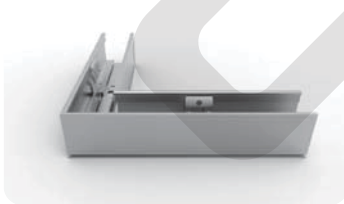

L Shape

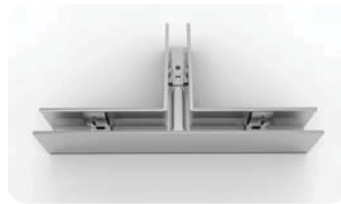

T Shape



Outward L Shape



Inward L Shape



X Shape

NOTE: Please contact our sales team for more detailed information

5.5 Bendable Stainless Steel Profile

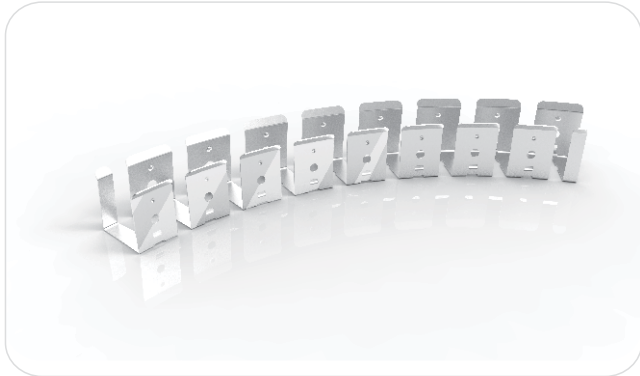

Model: F15-CS/PL

Note: Unless otherwise stated, the tolerance of the profile is ±0.5mm.

Installation Way

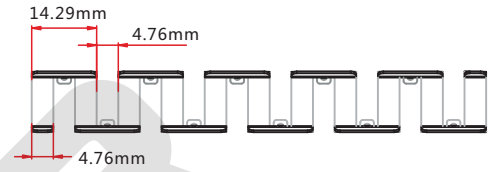
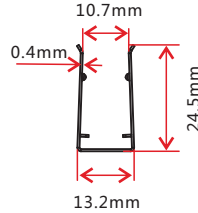
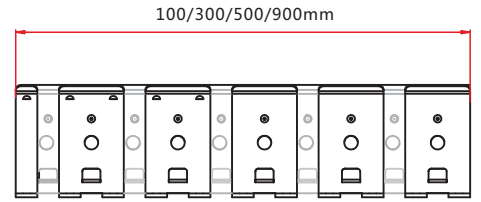

5.6 Recessed Mounting Profile

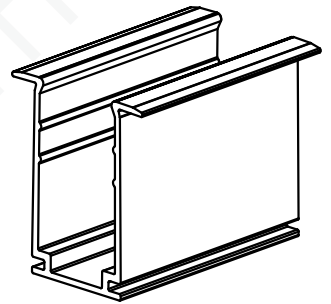
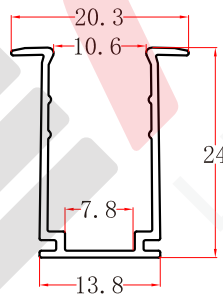
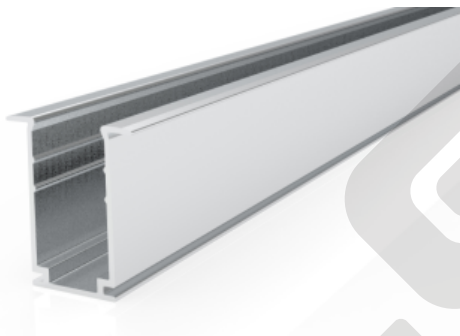

Note: Unless otherwise stated, the tolerance of the profile is ±0.5mm.

Installation Way

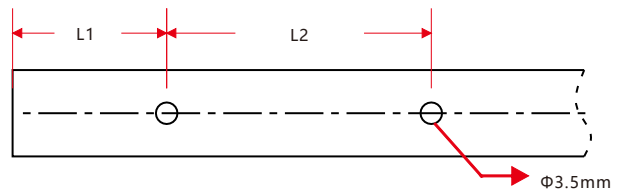

Model	W*H(mm)	Standard Length (mm)	L1 (mm)	L2 (mm)	Screw Hole (mm)	Hole Number
F15-RMA/PL	18*13.2	35	5	25	Φ3.5	2
		500	50	200	Φ3.5	3
		1000	100	200	Φ3.5	5
		2000	100	200	Φ3.5	10

6.Packaging

Packaging Method



Plastic Plate



White Box



Carton



Packaging Detail

Light Length	White Box Dimension (cm)	Carton Dimension (cm)	Numbers of White Box	Carton Weight (kg)
5m	35*4.2*46	48*37*24	5	10
10m	45*4.2*56	58*47*24	5	18
20m	61*4.2*72	74*63.5*10.5	2	15

7. Appendix

7.1 Product Naming Convention

C-SFR-XXX(-)X-XX-XXX-XXX-XXX-XXX

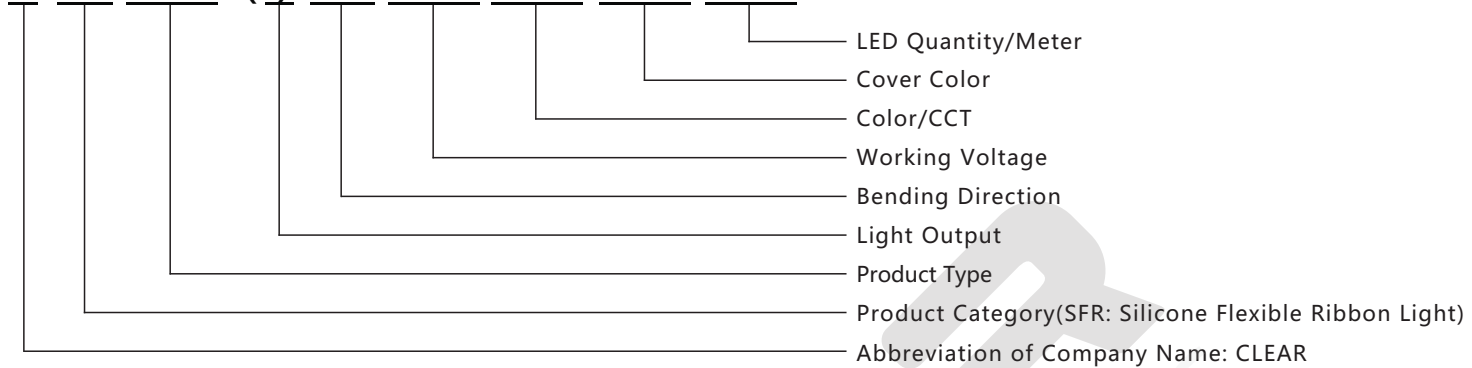

For Example: C-SFR-F15S6-HB-24CC-RGB-WM-60

7.2 Certificate

Certificating Type	Testing Organization	Certificate Serial Number	Report Reference
UL 2108	UL	20160726-E360029	E360029-20130322
CE-EMC	SGS	SZEM1712012372LMV	SZEM171201237201

7.3 Third-Party Test Report

Testing Item	Testing Organization	Report Number
RoHS	SGS	CANEC1202163502 A01
IP68: Screw type	TUV SUD	68.140.12.136.02
IP68: Clasp type	SGS	GZES140200135301
		GZES140200135401
		GZES140200135501
		GZES140200135701
		GZES140200135801
IPX8: Molding type	SGS	SZES141200357301
		SZES141200357401
		SZES141200357501
IPX8: Snap type	SGS	GZES160600792031

>>Note: The testing reports and certificates are available from the related official website.

7.4 Reliability Test of Light

TESTING ITEM	PERFORMANCE	STANDARD/REFERENCE VALUE/DESCRIPTION
PHOTOMETRIC TESTING	Spectrum Analysis	IES LM 79 (lumen, CCT, CRI, XY, SDCM, wave length)
	Photometric Distribution	IES LM 79(lumen intensity distribution & Lux diagram)
	Lumen Maintenance & Life Time	IES LM84 & IES TM28
TEMPERATURE RISE TESTING	Normal Temperature Test	UL1598 & UL2388 & IEC60598-1 & IEC60598-2-21
	Abnormal Operation Test	UL1598 & UL2388 & IEC60598-1 & IEC60598-2-21
MECHANICS & PHYSICS TESTING	Bending Test	Manufacturer-defined, 500 cycles
	Swing Test	UL2388, >750 cycles
	Tensile Test	Manufacturer-defined, > the weight of light in maximum connection length with both ends feed
	Twist Test	Manufacturer-defined, >200 cycles
	Ball Impact	UL1598 & UL2388 & IEC60598-1 & IEC60598-2-21
	IK07 IK08	IEC62262
WEATHERING TESTING	Swimming Pool Water Immersion Test	GB9667, PH6.8-7.6, free chlorine 0.3-0.6mg/L
	Sea Water Immersion Test	IEC60598-1, Salinity 4%
	Salt Spray Test	IEC68-2-11
	Outdoor Exposure	Manufacturer-defined
ENVIROMENT TESTING	Flame Resistant Test	UL94
	UV Exposure Test	ASTMG 154 , ISO 4892-3 , UVA@340nm
	IPX5 IPX6 IPX7 IPX8	IEC60529
ENDURANCE & THERMAL TEST LAB	Temperature Shock Test	Manufacturer-defined , -40°C-60°C (typical temperature range)
	Constant Temperature Test	Manufacturer-defined , 70°C (typical temperature)

7.5 (X,Y) Chromaticity Diagram

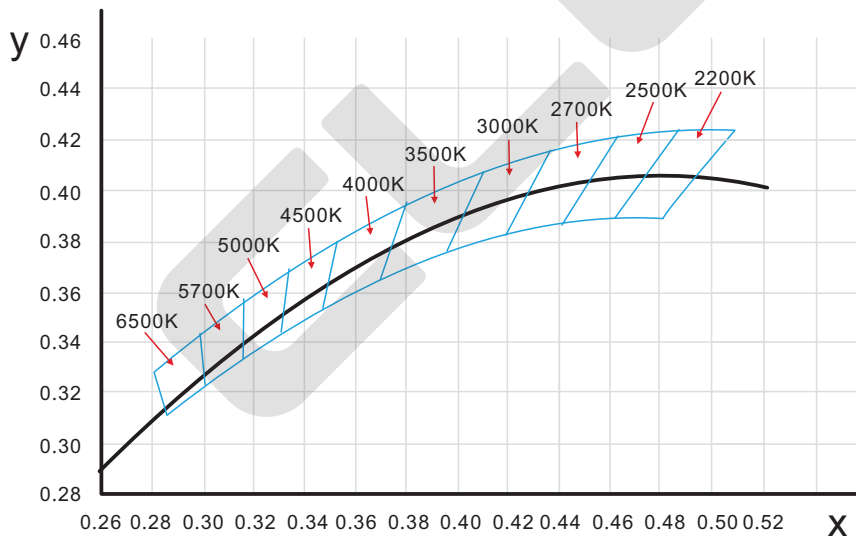

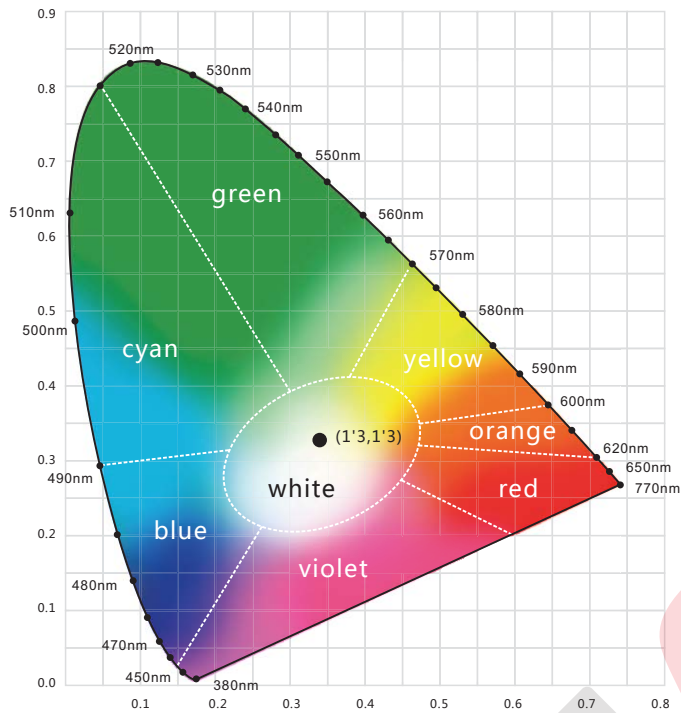

7.6 Wavelength of Color Light

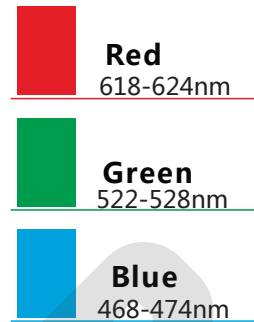

Light Color

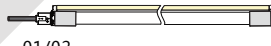

7.7 Loading Chart

Type.	Rated Power /mtr	Power Supply											
		35w	60w	75w	80w	100w	120w	150w	120w	150w	185w	240w	320w
F15	6.5w/7.2w/8w	3m	6m	7.5m	8m	10m	12m	15m			18m	24m	30m
	10.6w/11w/12w	2m	3.5m	4.5m	5m	6m	7m	10m			12m	14m	20m
	15w	2m	3m	4m	4.2m	5m			6m	8m	10m		
Energizing Way		DC input  01/02						DC input  01 02 DC input					

Note : 1. These are the light maximum recommended running length subject to selected power supply.
 2. For example: It is recommended to use one 80W power supply loading maximum 8m light (7.2w/m) or maximum 5m light (12w/m) by energizing the light one end.

7.8 Correlated Color Temperature

ANSI STANDARD

Nominal CCT Categories

Nominal CCT	Target CCT and tolerance(K)	Target D_{uv}	D_{uv} Tolerance Range
2200K	2238 ±102	0.0000	T_x :CCT of the source
2500K	2460±120	0.0000	For $T_x < 2870K$
2700K	2725 ±145	0.0000	0.000 ± 0.0060
3000K	3045±175	0.0001	For $T_x \geq 2870K$
3500K	3465±245	0.0005	$D_{uv}(T_x) \pm 0.0060$
4000K	3985±275	0.0010	where
4500K	4503±243	0.0015	$D_{uv}(T_x) = 57700 \times (1/T_x)^2$
5000K	5029±283	0.0020	-44.6 × (1/ T_x)
5700K	5667±355	0.0025	+0.00854
6500K	6532±510	0.0031	
Flexible CCT (2200-6500K)	$T_F^{1)} \pm \Delta T^{2)}$	$D_{uv} T_F^{3)}$	

Remark:

- T_f is chosen to be at 100K steps (2300,2400,.....,6400K), excluding the ten nominal CCTs listed in Table 1.
- $\Delta T = 1.1900 \times 10^8 \times T^3 - 1.5434 \times 10^4 \times T^2 + 0.7168 \times T - 902.55$
- Same as in the D_{uv} Tolerance Range.