

IP20 SELV 
 RoHS

Driver LCI 35 W 350/500/700/1050 mA TEC SR

TEC series

Product description

- Independent fixed output LED Driver
- Constant current LED Driver
- Output current 350, 500, 700 or 1,050 mA
- Max. output power 35 W
- Nominal life-time up to 50,000 h
- For luminaires of protection class I and protection class II
- For luminaires with M and MM as per EN 60598, VDE 0710 and VDE 0711
- Temperature protection as per EN 61347-2-13 C5e
- 5-year guarantee

Properties

- Casing: polycarbonat, white
- Type of protection IP20

Functions

- Overtemperature protection
- Overload protection
- Short-circuit protection
- No-load protection

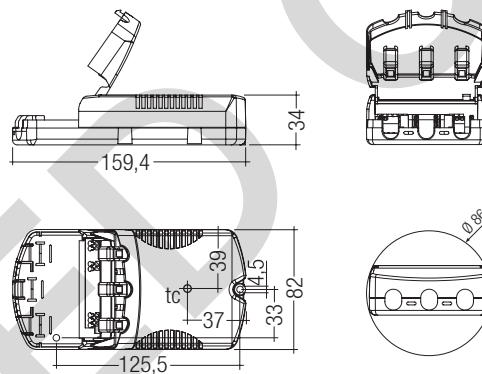

Technical data

Rated supply voltage	220 – 240 V
AC voltage range	198 – 264 V
Current at 50 Hz 230 V	0.17 A
Mains frequency	50 / 60 Hz
Overvoltage protection	300 V AC, 1 h
Max. input power	41.5 W
Typ. output power	35 W
THD (at 230 V, 50 Hz, full load)	< 20 %
Output current tolerance [®]	± 7.5 %
Turn on time (at 230 V, 50 Hz, full load)	≤ 0.7 s
Turn off time (at 230 V, 50 Hz, full load)	≤ 0.7 s
Hold on time at power failure	0 s
Ambient temperature ta	-20 ... +50 °C
Ambient temperature ta (at life-time 50,000 h)	40 °C
Max. casing temperature tc	75 °C
Storage temperature ts	-40 ... +80 °C
Dimensions L x W x H	159.4 x 82 x 34 mm

Ordering data

Type	Article number	Packaging, carton	Packaging, low volume	Packaging, high volume	Weight per pc.
LCI 35W 350mA TEC SR	87500193	20 pc(s).	280 pc(s).	1,120 pc(s).	0.181 kg
LCI 35W 500mA TEC SR	87500195	20 pc(s).	280 pc(s).	1,120 pc(s).	0.183 kg
LCI 35W 700mA TEC SR	87500197	20 pc(s).	280 pc(s).	1,120 pc(s).	0.181 kg
LCI 35W 1050mA TEC SR	87500199	20 pc(s).	280 pc(s).	1,120 pc(s).	0.185 kg



Standards, page 3

Wiring diagrams and installation examples, page 4

Specific technical data

Type	Output current ^①	Typ. power consumption (at 230 V, 50 Hz, full load)	Power factor at full load ^①	Efficiency at full load ^①	Power factor at min. load ^①	Efficiency at min. load ^①	Min. forward voltage ^①	Max. forward voltage ^①	Max. output voltage	Max. peak output current at full load ^{①②}	Max. peak output current at min. load ^{①②}	Typ. current ripple (at 230 V, 50 Hz, full load)
LCI 35W 350mA TEC SR	350 mA	38.5 W	0.98	90.0 %	0.95	88.5 %	50.0 V	100.0 V	115 V	630 mA	850 mA	± 25 %
LCI 35W 500mA TEC SR	500 mA	38.5 W	0.98	90.0 %	0.95	88.0 %	35.0 V	70.0 V	85 V	800 mA	1,120 mA	± 25 %
LCI 35W 700mA TEC SR	700 mA	39.0 W	0.99	89.5 %	0.96	86.5 %	25.0 V	50.0 V	60 V	1,170 mA	1,470 mA	± 30 %
LCI 35W 1050mA TEC SR	1,050 mA	39.5 W	0.98	88.0 %	0.94C	83.0 %	16.5 V	33.5 V	40 V	1,800 mA	2,350 mA	± 30 %

^① Test result at 230 V, 50 Hz.

^② The trend between min. and full load is linear.

^③ Output current is mean value.

PHASED OUT

Standards

- EN 55015
- EN 60598-1
- EN 61000-3-2
- EN 61000-3-3
- EN 61347-1
- EN 61347-2-13
- EN 61547
- EN 62384

Overload protection

If the output voltage range is exceeded the LED Driver reduces the LED output current. After elimination of the overload the nominal operation is restored automatically.

Overtemperature protection

The LED Driver is protected against temporary thermal overheating. If the temperature limit is exceeded the output current is reduced to limit t_c at a certain level. It restarts automatically. The temperature protection is activated typically at 8 °C above t_c max.

Short-circuit behaviour

In case of a short circuit on the secondary side (LED) the LED Driver switches into hic-cup mode. After elimination of the short circuit the nominal operation is restored automatically.

No-load operation

The LED Driver works in constant voltage mode. In no-load operation the output voltage will not exceed the specified max. output voltage (see page 2).

Installation instructions

The LED module and all contact points within the wiring must be sufficiently insulated against 4.0 kV surge voltage. Air and creepage distance must be maintained.

Replace LED module

1. Mains off
2. Remove LED module
3. Wait for 60 seconds
4. Connect LED module again

Hot plug-in or secondary switching of LEDs is not permitted and may cause a very high current to the LEDs.

Expected life-time

Type	t_a	40 °C	50 °C	60 °C
LCI 35W xxxmA TEC SR	t_c	65°C	75°C	x
	Life-time	50,000h	30,000h	x

The LED Drivers are designed for a life-time stated above under reference conditions and with a failure probability of less than 10 %.

Maximum loading of automatic circuit breakers

Automatic circuit breaker type	C10	C13	C16	C20	B10	B13	B16	B20	Inrush current
Installation Ø	1.5mm ²	1.5mm ²	1.5mm ²	2.5mm ²	1.5mm ²	1.5mm ²	1.5mm ²	2.5mm ²	I_{max} Time
LCI 35W 350mA TEC SR	40	60	80	100	30	45	60	70	10 A 100 µs
LCI 35W 500mA TEC SR	40	60	80	100	30	45	60	70	10 A 100 µs
LCI 35W 700mA TEC SR	40	60	80	100	30	45	60	70	10 A 100 µs
LCI 35W 1050mA TEC SR	40	60	80	100	30	45	60	70	10 A 100 µs

Harmonic distortion in the mains supply (at 230 V / 50 Hz and full load) in %

	THD	3.	5.	7.	9.	11.
LCI 30W 350mA TEC SR	20	6	3	2	2	2
LCI 30W 500mA TEC SR	20	8	3	2	2	2
LCI 30W 700mA TEC SR	20	9	4	3	2	2
LCI 30W 1050mA TEC SR	20	10	4	3	2	2

Fixing conditions

Dry, acidfree, oilfree, fattfree. It is not allowed to exceed the maximum ambient temperature (t_a) stated on the device. Minimum distances stated below are recommendations and depend on the actual luminaire. Is not suitable for fixing in corner.

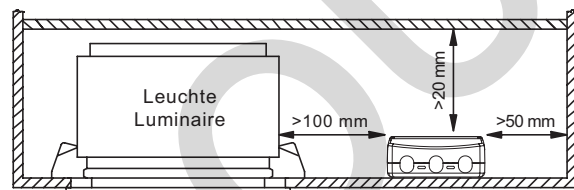

Storage conditions

Humidity: 5 % up to max. 85 % not condensed (max. 56 days/year at 85 %)

Storage temperature: -40 °C up to max. +80 °C

The devices have to be within the specified temperature range (t_a) before they can be operated.

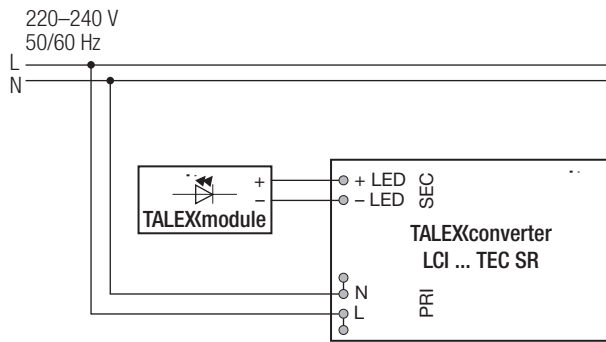
Wiring diagram**Glow wire test**

according to EN 60598-1 with increased temperature of 850 °C passed.

Isolation and electric strength testing of luminaires

Electronic devices can be damaged by high voltage. This has to be considered during the routine testing of the luminaires in production.

According to IEC 60598-1 Annex Q (informative only!) or ENEC 303-Annex A, each luminaire should be submitted to an isolation test with 500 V_{DC} for 1 second. This test voltage should be connected between the interconnected phase and neutral terminals and the earth terminal. The isolation resistance must be at least 2 MΩ.

As an alternative, IEC 60598-1 Annex Q describes a test of the electrical strength with 1500 V_{AC} (or 1.414 x 1500 V_{DC}). To avoid damage to the electronic devices this test must not be conducted.

Additional information

Additional technical information at www.tridonic.com → Technical Data

Guarantee conditions at www.tridonic.com → Services

Life-time declarations are informative and represent no warranty claim. No warranty if device was opened.

Wiring type and cross section

The wiring can be in stranded wires with ferrules or solid. For perfect function of the cage clamp terminals the strip length should be 4 – 5 mm for the input terminal.

The max. torque at the clamping screw (M3) is 0.2 Nm.

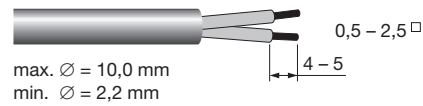
Input / Output terminal**Wiring instructions**

- All connections must be kept as short as possible to ensure good EMI behaviour
- Mains leads should be kept apart from LED Driver and other leads (ideally 5 – 10 cm distance)
- The maximum length of output wires is 2 m.
- Secondary switching is not permitted.
- Incorrect wiring can damage LED modules.
- Through wiring of mains is connecting additional LED Driver only. Max. permanent current of 16 A may not be exceeded.
- The wiring must be protected against short circuits to earth (sharp edged metals parts, metal cable clips, louver, etc.)

Diagrams LCI 35W 350mA TEC SR

Efficiency vs load

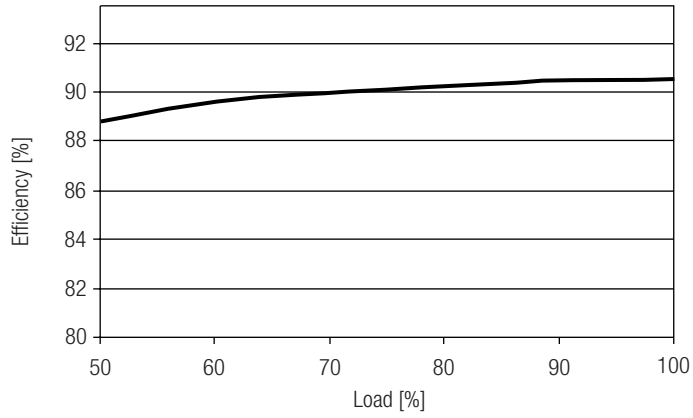

Power factor vs load

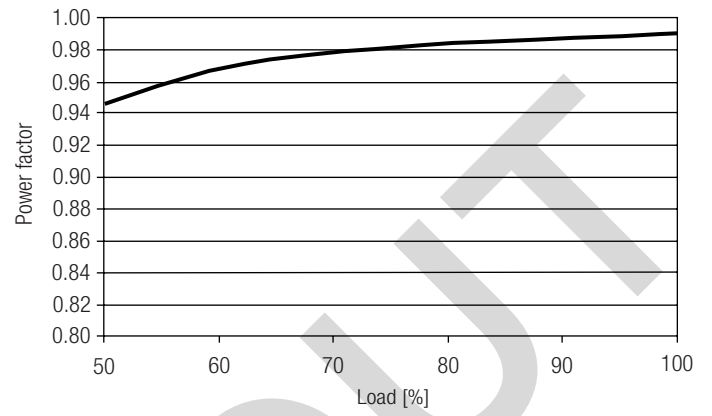

THD vs load

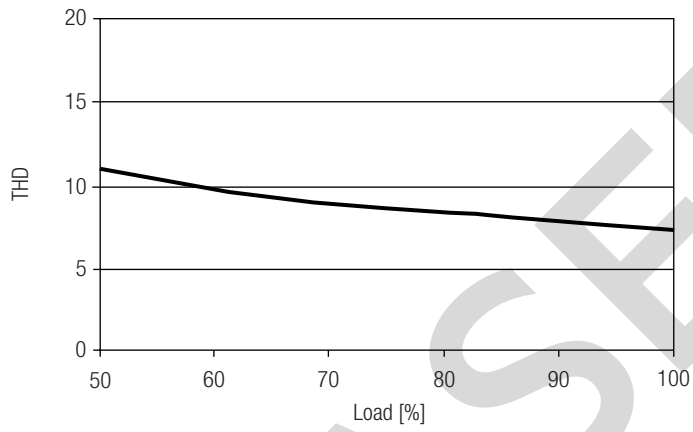

Diagrams LCI 35W 500mA TEC SR

Efficiency vs load

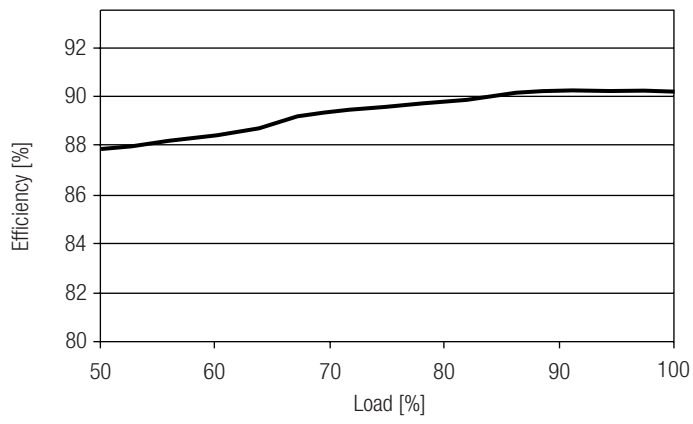

Power factor vs load

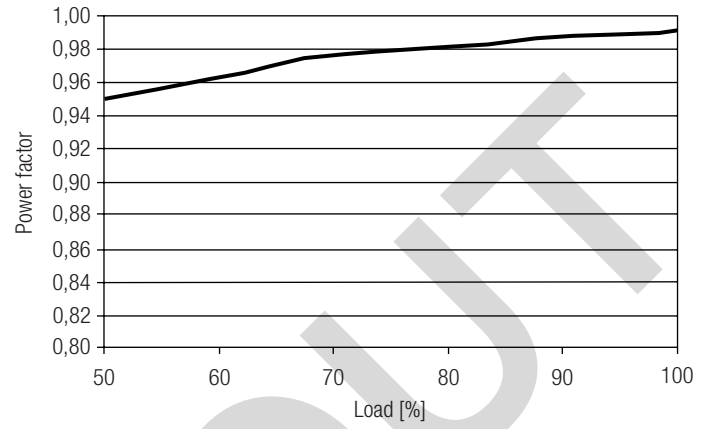

THD vs load

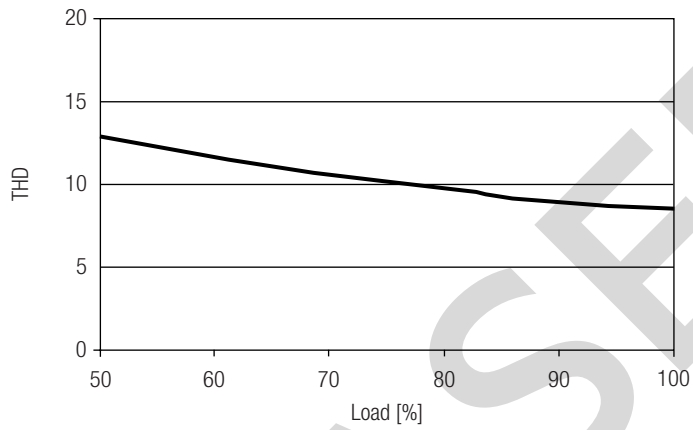

Diagrams LCI 35W 700mA TEC SR

Efficiency vs load

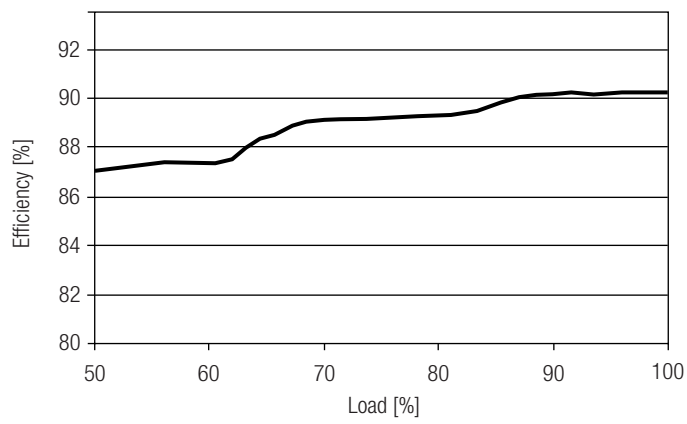

Power factor vs load

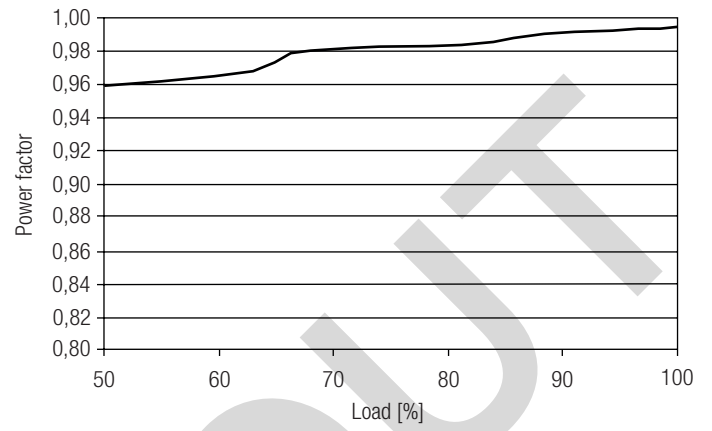

THD vs load

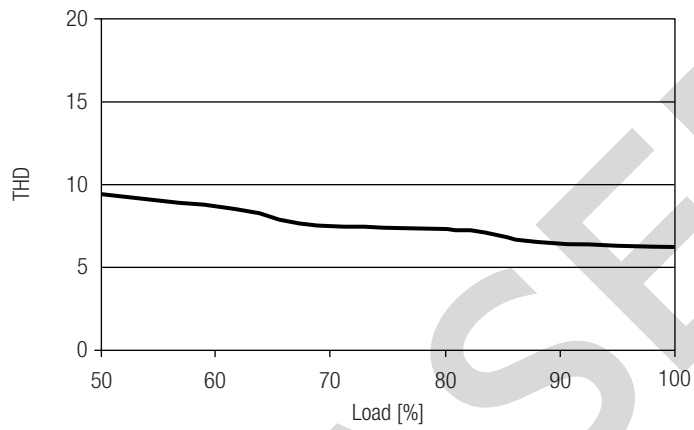

Diagrams LCI 35W 1,050mA TEC SR

Efficiency vs load

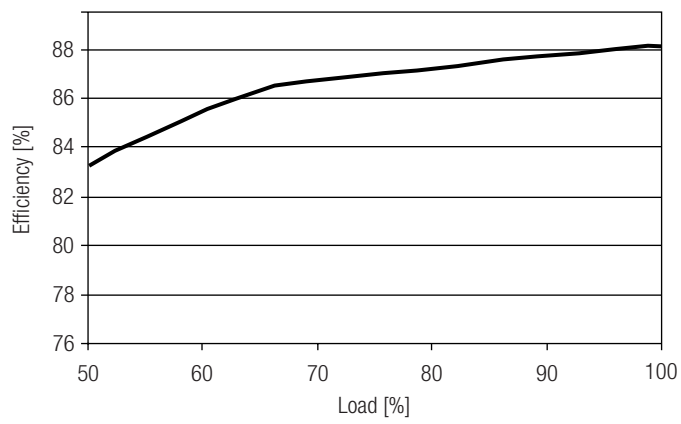

Power factor vs load

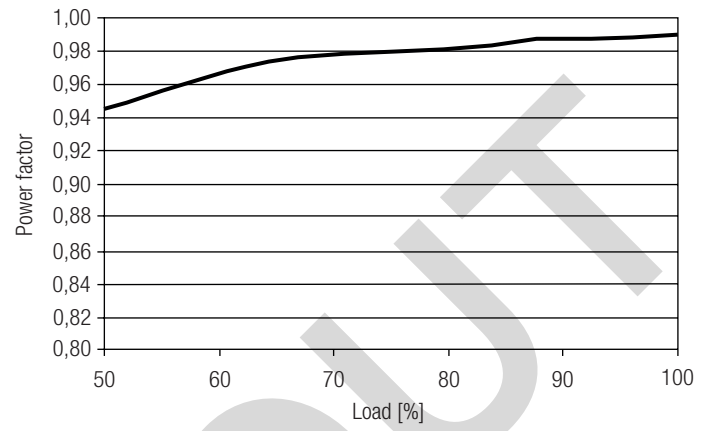

THD vs load

