

DAI Expander

Datasheet

DAI System Extension

device for simple DAI line expansion with integrated Bus power supply

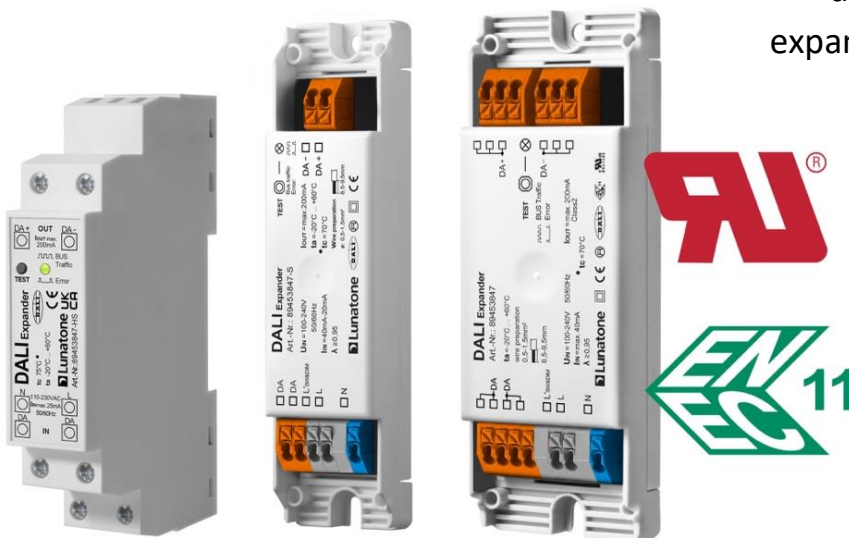

Art. Nr. 89453847
Art. Nr. 89453847-S
Art. Nr. 89453847-HS

DALI Expander DALI System Extension

Overview

- Device for simple DALI line expansion
- Control of several DALI-devices via one DALI-address
- For the superordinate DALI line the DALI Expander acts as a DALI EVG (DALI IN) with a single address
- Output (DALI OUT) with DALI power supply (200mA) for the supply of DALI EVG's and DALI control modules
- Forwarding commands received at the input (DALI IN) to the output (DALI OUT) broadcast
- Alternative control options of the DALI-output line via Switch&Dim-input (Broadcast)
- Galvanic separation between DALI-lines
- Available for DIN rail mounting (for integration in protection class II devices) or as independent control gear (for remote ceiling or integration in luminaires)

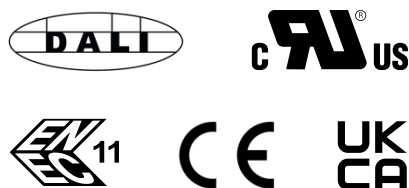

Specification, Characteristics

type	DALI Expander		
article number	89453847	89453847-S	89453847-HS
input: L, N			
input type	supply, mains- voltage		
marking terminals	L, N		
input voltage range	100Vac ... 240Vac	110Vac ... 230Vac	
max. input supply current	40mA (@120Vac), 20mA (@240Vac)		
input supply frequency	50Hz / 60Hz		
max. power consumption	5,3W		
start-up time	250ms		
input: DA, DA			
input type	DALI control input		
marking terminals	DA, DA		
input voltage range	9,5V ... 22,5V		
max. current consumption DALI	2mA		

article number	89453847	89453847-S	89453847-HS
----------------	----------	------------	-------------

input: L', N

input type	SwitchDim - control input	-
marking terminals	L', N	-
input voltage range	230Vac	-
input supply frequency	50Hz/60Hz	-
control impulse length min.	40ms	-
control impulse length long press	500ms	-
max. wire length	10m - 15m, depending on type of installation and interference fields.	

output: DA+, DA-

output type	DALI supply	
marking terminals	DA+, DA-	
output voltage range	12Vdc ... 20,5Vdc	
guaranteed DALI supply current	200mA	
open circuit proof	yes	
short circuit proof	yes	

insulation data:

impulse voltage category	II	
pollution degree	2	
rated insulation voltage	250V	
insulation DALI-output (DA+,DA-) / supply (L,N) DALI-input / DALI output(DA+, DA-) DALI-input / supply (L,N)	reinforced isolation	
insulation test voltage DALI-output/mains	3000Vac	

environmental conditions:

storing and transportation temperature	-20°C ... +75°C	
operational ambient temperature	-20°C ... +60°C	
rel. humidity, none condensing	15% ... 90%	

general data:

dimensions (l x w x h)	120mm x 41mm x 22mm	120mm x 30mm x 22mm	98mm x 17,5mm x 56mm
mounting	remote ceiling, integration in class II devices		DIN rail, integration in class II devices
rated max. temperature tc	70°C		75°C
expected life time @tc	50.000 h		
protection class	II in intended use		
protection degree housing	IP40		IP40
protection degree terminals	IP20		IP20

Artikelnummer	89453847	89453847-S	89453847-HS
---------------	----------	------------	-------------

terminals:

connection type	spring terminal connector	screw connector
wire size solid core	0,5 ... 1,5 mm ² (AWG20 ... AWG16)	0,5 ... 2,5 mm ² (AWG20 ... AWG14)
Wire size stranded wired	0,5 ... 1,5 mm ² (AWG20 ... AWG16)	0,5 ... 2,5 mm ² (AWG20 ... AWG14)
wire size using wire end ferrule	0,25 ... 1 mm ²	0,25 ... 1,5 mm ²
stripping length	8,5 ... 9,5mm / 0,33 ... 0,37inch	7 mm / 0,27 inch
locking torque	-	0,5Nm
release of wire	push button	open screw

standards:

DALI	EN 62386-101		
EMC	EN 61547 EN 50015 / IEC CISPR15		
safety	EN 61347-2-11 EN 61347-1		
markings	ENEC-11, cURus, CE	CE	CE, UKCA
UL file number	- E501360	-	-

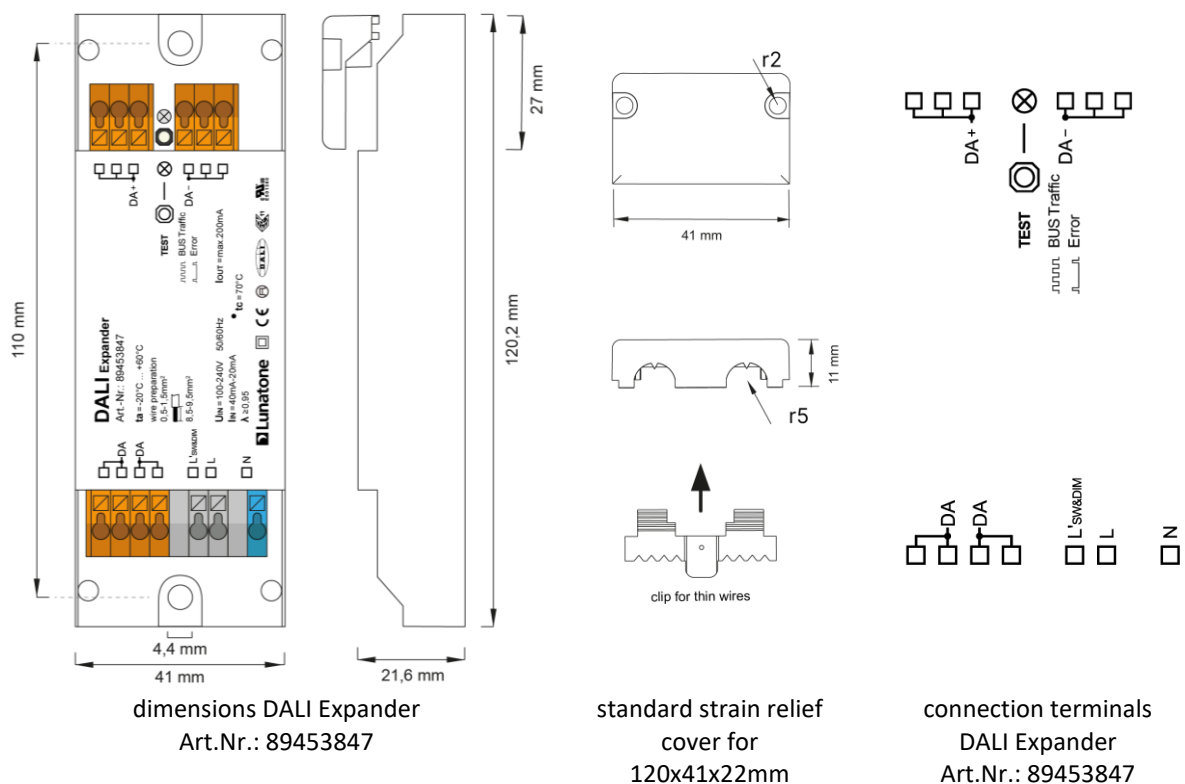

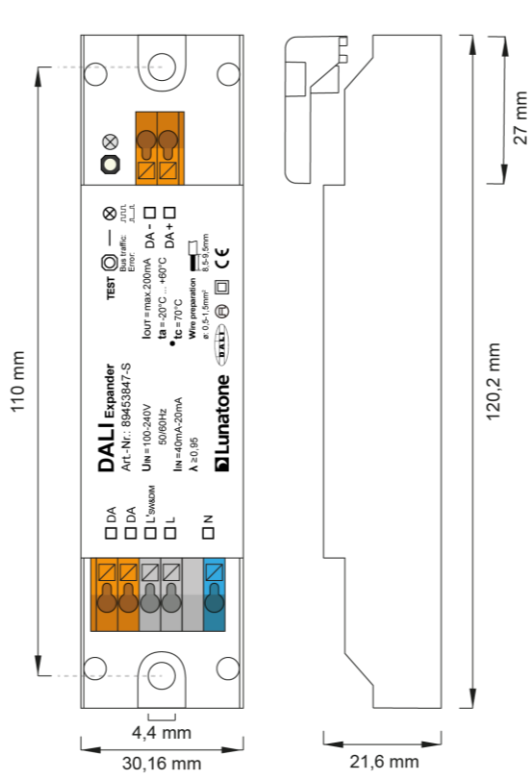

dimensions DALI Expander S
 Art.Nr.: 89453847-S
 Art.Nr.: 89452937-DES

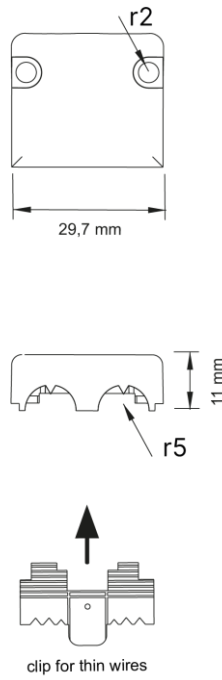

standard strain relief cover
 for 120x30x22mm

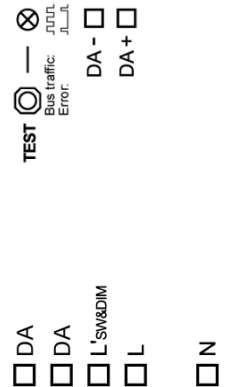

connection terminals
 DALI Expander S
 Art.Nr.: 89453847-S

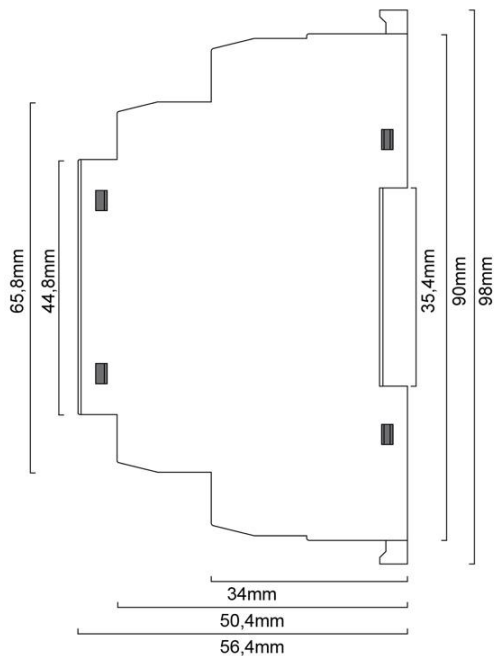

dimensions DALI-Expander HS
 89453847-HS
 89452937-HS

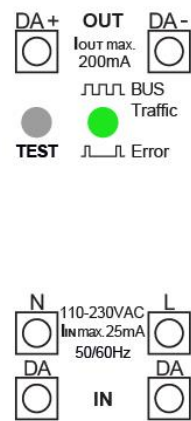
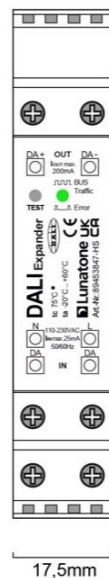

connection terminals
 DALI-Expander HS
 89453847-HS
 89452937-HS

Installation

- The DALI Expander is intended for remote installation in the ceiling or in an enclosure, ensure proper cable relief for installation in protection class II devices
- The DALI Expander (HS-type) is suited for DIN rail mounting, ensure protection against electric shock by an appropriate enclosure
- The wiring should be carried out as a permanent installation in a dry and clean environment.
- Installation may only be carried out in a voltage-free state of the system and by qualified specialists.
- National regulations for setting up electrical systems must be followed.
- connect power supply terminals L and N to mains voltage according to the labelling
- the polarity of the output voltage is marked on the housing (DA+, DA-)
- The DALI line may be routed together with the mains voltage (in one cable or as single wires in a tube)
- The DALI-line must **not** be connected to the mains or other extra low voltage systems
- Only 1 wire may be connected to each terminal. When using double wire end

ferrules, the connection capacity of the terminal must be considered.

- The DALI wiring can be realised with standard low-voltage installation material. No special cables are required.
- Wiring topology of the DALI-line: Line, Tree, Star
- Wiring check by pressing the test button: the LED is flashing and all luminaires connected to the DALI system will be controlled by a test sequence (on, off, dimming). To quit the test mode press the test button again.



Attention: The DALI-signal is not classified as SELV circuit (Safety Extra Low Voltage). Therefore, the installation regulations for low voltage apply.



The voltage drop on the DALI line must not exceed 2V at maximum length (300m) and maximum bus load (250mA).

- Do not use standard DC power supplies on the DALI-line, since they do not meet the requirements for DALI communication



Attention: an unsuitable DALI power supply can cause damage of the DALI devices!

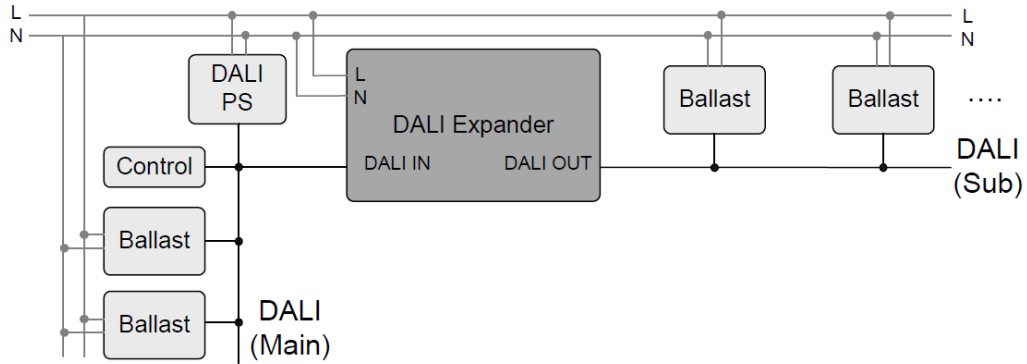

Expansion of a DALI line (Main) with a DALI subordinate line (all control commands sent to the DALI Expander are sent Broadcast to the DALI sub-line.)

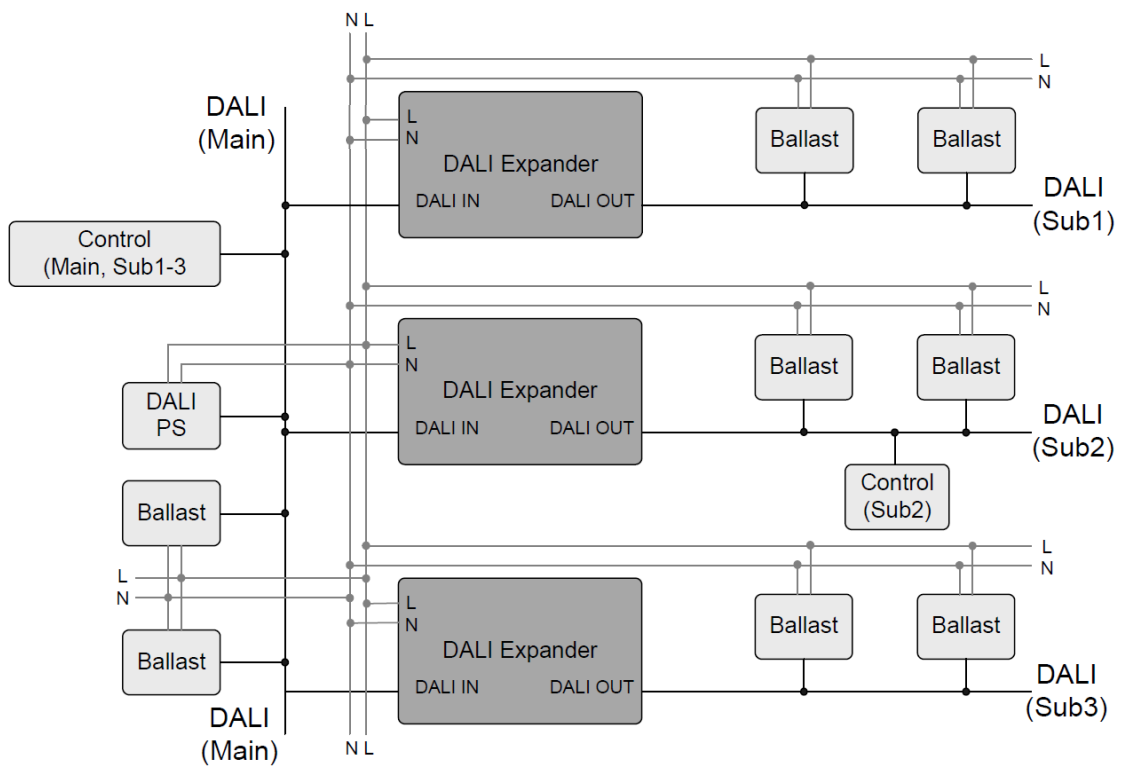

Expansion of a DALI line (Main) with multiple broadcast controllable DALI sub-lines. The additional control module in DALI (Sub2) enables the specific control of the sub-line.

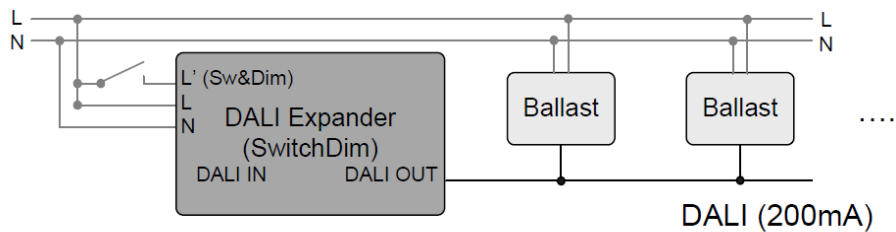

Control of DALI-ballasts via SwDim (DALI-Expander only)

Addressing and Configuration

- after installation the DALI Expander is ready for operation
- It must be ensured that the maximum current consumption of the DALI devices on the output side does not exceed the guaranteed output current (200mA) of the DALI Expander
- The SwitchDim input and DALI-Broadcast commands can be used to control the device immediately. (Maximum cable lengths for SwitchDim are: 10-15m (depending on the version and interference fields).)
- The DALI Expander can be addressed with the DALI Cockpit PC Software. When using the DALI Cockpit Software, the PC must be connected to the DALI bus via a suitable interface module (DALI USB, DALI 4Net, DALI SCI RS232). The DALI Expander is automatically recognised by the DALI Cockpit during the addressing process and listed in the device overview.
- Scene values, groups and other DALI settings of the devices at the output sub-line can be configured in the DALI Cockpit via the DALI Expander device page (both DALI and DALI-2 gears are supported). Also settings of the DALI Expander itself are available, see section “Function”.
- Status-LED:
 - flashing 5Hz, 50% on: test mode
 - flashing 2Hz, 5% on : error
 - flashing 2Hz, 90% on: activity

Function

With the DALI-Expander the number of DALI control gear can be extended. On the input side (main DALI Line) the DALI-Expander represents one device (one DALI address). All commands received by the device are forwarded broadcast to the sub-line (DALI OUT). Hence control gear connected to DALI OUT can be controlled via the one DALI address of the DALI Expander. The power supply for the DALI sub-line is provided by the expander itself (200mA). For command forwarding there are no device type specific restrictions. From firmware version 1.3 on, the DALI-2 command “Go to Last Active Level” is also supported.

The test button can be used to start and stop a test sequence for testing the DALI sub-line.

Behaviour on System Failure

Firmware version 1.4 and higher: A system failure on the input results in a system failure on the output. If required, the power supply of the DALI sub-line can be reactivated by pressing the test button on the device.

Firmware version 1.8 and higher: the behaviour on the DALI output side (secondary) in case of a system failure on the input side (primary) can be configured. Following options are available:

- switch off
- switch off for 650 msec
- do not turn off
- do not turn off and RECALL MAX after 600 msec
- do not turn off and RECALL MIN after 600 msec
- do not turn off and send light level (System Failure level) after 600 msec

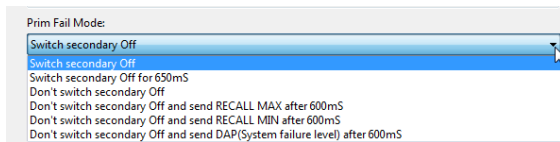

If SwitchDim operation is detected, the bus supply is always switched on.

Command repetition

Firmware version 1.9 and higher: light level commands (DAP) can be repeated on the output side with a defined period (default=5s). This feature ensures that after a phase failure and voltage recovery the luminaires return to the desired light level and do not remain at the power-on level.

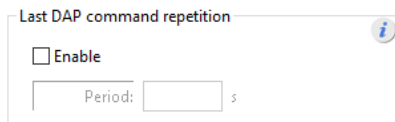

Queries – query lamp failure

Firmware version 1.2. and higher: A LAMP FAILURE of the DALI sub-line can be queried. Because of the strict DALI-Timing the answer from the DALI sub-line is not received in time - to get a valid response, the query must be sent twice in a row.

DALI commands:

- Query Actual Level (=255 on Lamp Failure)
- Query Status (Bit[1]=1 on Lamp Failure)
- Query Lamp Failure (answer = YES on Lamp Failure)

Application Example

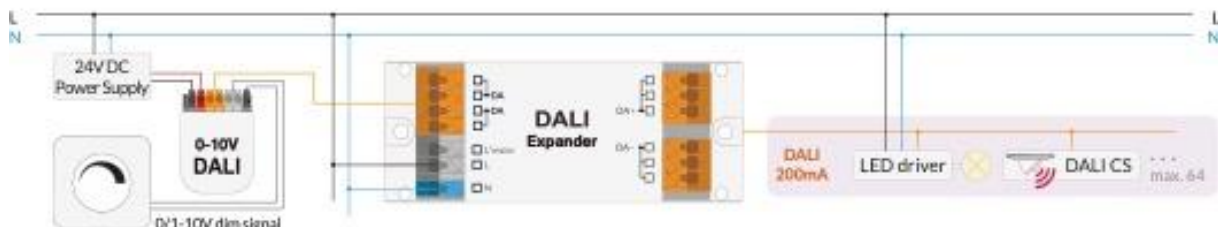

Control of 64 DAL luminaires with a 0-10V control device and a 0-10V to DALI converter (Art.Nr: 86458352)

Purchase Information

Art.Nr. 89453847: DALI Expander with integrated bus power supply for remote ceiling

Art.Nr. 89453847-S: DALI Expander with integrated bus power supply for remote ceiling in narrow housing for luminaires or rail installation

Art.Nr. 89453847-HS: DALI Expander with integrated bus power supply for DIN rail

Additional Information and Equipment

Lunatone datasheets, manuals and software
<http://www.lunatone.com/en/downloads-a-z/>

Lunatone DALI products
<http://www.lunatone.com/en>

DALI-Cockpit – free configuration tool from Lunatone for DALI systems
<https://www.lunatone.com/en/product/dali-cockpit/>

Contact

Technical Support: support@lunatone.com

Requests: sales@lunatone.com

www.lunatone.com



Disclaimer

Subject to change. Information provided without guarantee.
The datasheet refers to the current delivery.

The function in installations with other devices must be tested for compatibility in advance.