

# Flexglo™ F15E RGBW Light (Silicone)



Certification Mark	UL	CE
Test Standard/Directive	UL2108 Class 2	CE-EMC
Certificate Serial Number	20180801-E360029	SZEM1712012372LMV
Report Reference	E360029-20130322	SZEM171201237201



Ambient Working Temperature ≤15W/m -40 ~ 45°C / -40 ~ 113°F	Ambient Installation Temperature ≥ -40°C / -40°F	Storage Temperature -40 ~ 60°C / -40 ~ 140°F
Max. Mounting Surface Temperature 85°C / 185°F	Constant Voltage DC24V	

*specified in the non-working state of light.*

## C-SFR-F15E-HB



C-SFR-F15B-HB-24CV-RGBW(27K)-WM-60-15W-100

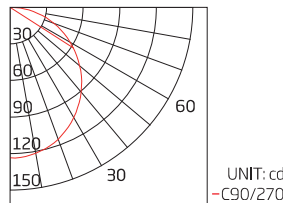

Min. Bending Diameter 120mm/4.72in	Min. Cutting Length 100mm/3.94in 6LEDs	11.5mm/0.45in 2mm/0.03in	LIGHT SURFACE Horizontal Bending
Bending-extreme 4557 times	Tensile-instantaneous >60 kg.f	Twist-extreme 4679 times	

AVERAGE BEAM ANGLE (50%): 111.4°

*Warning: Extreme Destructive Tests in Laboratory only, and it's forbidden to operate in practice.*

Note:

1. The illuminated light length shall be an integral multiple of min. cutting length.
2. The waterproof reliability of the lighting fixture depends on the IP rating of connector, and please make sure connector is properly assembled before installation. The highest IP rating we can achieve is IP68.

## Feature

Flexglo™ F15E RGBW Light (Silicone) is a color changing product with qua-chip SMD5050 RGBW LEDs as light source, an ideal product for project where premium LED is required, RGBW color changing is achievable via a 4 channel PWM controller or any compatible DMX-512 controller, and 2700K and 4000K in white color are optional.

Thanks to the excellent weatherproof and UV-resistant performance of silicone material, it features a wide ambient working temperature range of -40-55 °C, especially suitable for harsh environment application. Combined with the adoption of the DryWire™ technology, the IP68 Injection-moulded Connector is engineered for outdoor use, owing to its elegant appearance and strong adhesiveness acquired by the liquid silicone injection workmanship. This product features a ultra long lifespan in outdoor application by leveraging other ClearTech™ such as the PinBoost™ technology enhancing physical reliability of light engine, the TwinFlex™ technology improving the conductivity and optimizing heat dissipation performance, the C-Mask™ technology making the light body self-cleaning and anti-UV and enabling consistent illumination.

## Item Code

C	SFR	F15E	HB	24CV	RGBW (27K)	WM	60	15W	100
Company	Material	Product Series	Bending Direction	Voltage & Circuit Type	Color	Base & Lighting Surface	LEDs Qty/m	Power/m	Min. Cutting Length (mm)
Clear	SFR= Silicone Flex Ribbon	F15E= RGBW	HB= Horizontal Bending	DC24V & Constant Voltage	RGBW(27K)= RGB & 2700K RGBW(30K)= RGB & 3000K RGBW(40K)= RGB & 4000K	WM= White & Milky	60	15W	100

## Electrical Parameter

Category	C-SFR-F15E-HB
Voltage	24
Current (mA/m)	625.0
Power (W/m)	15
Circuit Type	CV
LED Type	5050
LEDs Qty/m	60
LEDs Qty/unit	6
Unit/m	10
Min. Cutting Length (mm)	100
Min. Cutting Length (in)	3.94

## Optical Parameter

Item Code	Finished Product						LED	
	Color	Wavelength/ CCT Tolerance	Color Tolerance	CRI	Lumen/m	Lumen/ft	Color Tolerance	CRI
C-SFR-F15E-HB-24CV-RGBW(27K)-WM-60-15W-100	Red	618-624nm			50lm	15lm	<3nm	
	Green	522-530nm			120lm	37lm	<3nm	
	Blue	468-474nm			25lm	8lm	<3nm	
	White	2725±85K	<5SDCM	80	120lm	37lm	<2.3SDCM	82~87
C-SFR-F15E-HB-24CV-RGBW(30K)-WM-60-15W-100	Red	618-624nm			50lm	15lm	<3nm	
	Green	522-530nm			120lm	37lm	<3nm	
	Blue	468-474nm			25lm	8lm	<3nm	
	White	3045±175K	<5SDCM	80	120lm	37lm	<2.3SDCM	82~87
C-SFR-F15E-HB-24CV-RGBW(40K)-WM-60-15W-100	Red	618-624nm			50lm	15lm	<3nm	
	Green	522-530nm			120lm	37lm	<3nm	
	Blue	468-474nm			25lm	8lm	<3nm	
	White	3985±150K	<5SDCM	80	120lm	37lm	<2.3SDCM	82~87

Note:

1. CCT Tolerance refers to target CCT and tolerance (ANSI C78.377).
2. Color Tolerance refers to CLEAR standard for finished product and LED.





## Max. Running Length Input: DC24V

Type	Snap Connector		Silicone Injection-moulded Connector	
IP Rating	IP67		IP68	
Item Code	Single-end Feed	Double-end Feed	Single-end Feed	Double-end Feed
C-SFR-F15E-15W-Static full loading	8m/26.24ft	16m/52.48ft	8m/26.24ft	16m/52.48ft
C-SFR-F15E-15W-Dynamic operating	12m/39.36ft	24m/78.72ft	12m/39.36ft	24m/78.72ft
Dimension of Connector	Page F15 135		Page F15 149	
Max.Packing Length	Page F15 198			













Note:

1. Above conclusion is based on voltage drop testing result of the light with 0.3m (0.98ft) cable only.
2. The maximum running length is based on the light in static full loading status exceptionally stated dynamic operating.
3. Above running length is only the light length excluding lengths of connectors, Please refer to the specific dimension of each connector.
4. The delivery length might be subject to the maximum packing length.

# F15E Connector (Silicone)

Type/IP Rating	Bending Direction	Front Connector End	Front Connector Side from Left	Front Connector Side from Right	Front Connector Bottom
Snap Connector IP67	HB	 F15E-HB-SM/FC-01/02-E- 0,3m/1m/3m/5m/ 10m/15m/20m 20AWG*1+22AWG*4	N/A	N/A	N/A
Silicone Injection-moulded Connector IP68	HB	 F15E-HB-SIM/FC-01/02-E- 0,3m/1m/3m/5m/ 10m/15m/20m 20AWG*1+22AWG*4	 F15E-HB-SIM/FC-02-SL- 0,3m/1m/3m/5m/ 10m/15m/20m 20AWG*1+22AWG*4	 F15E-HB-SIM/FC-01-SR- 0,3m/1m/3m/5m/ 10m/15m/20m 20AWG*1+22AWG*4	 F15E-HB-SIM/FC-01/02-B- 0,3m/1m/3m/5m/ 10m/15m/20m 20AWG*1+22AWG*4

# F15 Mounting Profile

Picture	Name/Item Code	Installation Way
	Aluminum Profile F15-A/PL-35/500/1000/2000mm	 
	Flange Aluminum Profile F15-FA/PL-35/500/1000/2000mm	
	Serrated Aluminum Profile F15-SA/PL-20/500/1000/2000mm	     

Type/IP Rating	Seamless Middle Connector & Power Feed	Middle Connector & Power T-feed	Middle Connector	Jumper	End Cap
----------------	--	---------------------------------	------------------	--------	---------

Snap Connector

N/A



N/A



IP67

N/A

F15E-HB-SN/MC-PTF-01/02-0.3m/1m/3m  
20AWG\*1+22AWG\*4

N/A

F15E-HB-SN/JU-01/02-0.3m/1m  
20AWG\*1+22AWG\*4

F15-SN/EC-01/02

Silicone Injection-moulded Connector

N/A



N/A



IP68

N/A

F15E-HB-SIM/MC-PTF-0.3m/1m/3m  
20AWG\*1+22AWG\*4

N/A

F15E-HB-SIM/JU-0.3m/1m  
20AWG\*1+22AWG\*4

F15-SIM/EC

Picture

Name/Item Code

Installation Way



Flange Serrated Aluminum Profile  
F15-FSA/PL-20/500/1000/2000mm



Bendable Serrated Aluminum Profile  
F15-BSA/PL-500/1000mm



# Flexglo™ F15E Wiring Diagram

1. Please use a constant voltage power supply with corresponding output voltage, and rated wattage of the power supply shall be 25% more than the actual power consumption of light to increase its life expectancy;
2. A compatible controller is required to achieve various light changing effects;
3. The rated power of controller/decoder shall be higher than the actual power consumption of light; its frequency range shall be 100~2000Hz, and 500Hz is recommended;
4. Full loading in RGBW is not recommended to avoid the overheating of light. 5. This wiring diagram is using the mains of AC230V with brown and blue wires as an example, and please connect with the corresponding live and neutral wires for other mains electricity;

Input AC100~240V

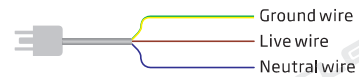

USA



Europe



Australia



United Kingdom

5. Types of standard plugs are optional if power cord is purchased from CLEAR.

## Single-end Feed

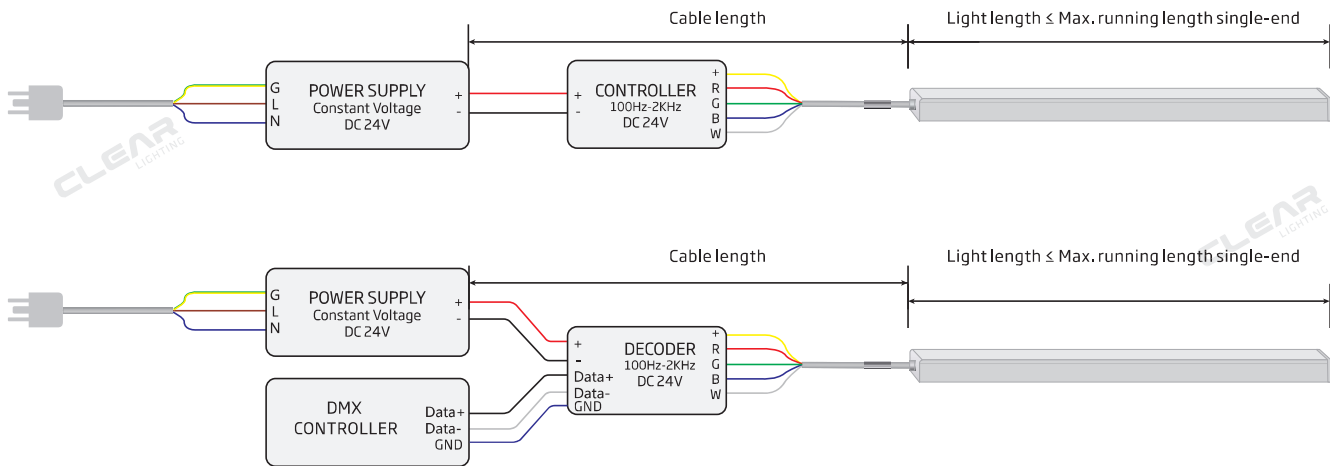

### Light Length:

The length of the longest single light in parallel connection or sum of lights in series connection.

### Cable Length:

The length of an electrical cable between power output end and light input end, and the cables for serial interconnection are inclusive.

## How to Minimize Voltage Drop and Signal Transmission Attenuation

1. Please ensure the cable length is not more than the table "Max. Cable Length" according to light length and its wire gauge.
2. Please ensure the light length is less than the cable "Max. Running Length Single-end Feed".
3. Shielded Twisted Pair cable is required to be used to connect DMX master controller and decoder, and its length shall be less than 300m.

## Max. Running Length Single-end Feed

Input: DC24V

Connector Type	Snap Connector	Injection-moulded Connector	Dual Injection-moulded Connector
Wire Gauge	20AWG*1+22AWG*4	20AWG*1+22AWG*4	20AWG*1+22AWG*4
C-FR-F15E-15W-Static full loading	5m/16,4ft	5m/16,4ft	5m/16,4ft
C-FR-F15E-15W-Dynamic operating	8m/26,24ft	8m/26,24ft	8m/26,24ft
C-SFR-F15E-15W-Static full loading	8m/26,24ft	8m/26,24ft	/
C-SFR-F15E-15W-Dynamic operating	12m/39,36ft	12m/39,36ft	/

Note:

1. Above conclusion is based on voltage drop testing result of the light with 0,3m (0,98ft) cable only.
2. The maximum running length is based on the designated light in static full loading status exceptionally stated dynamic operating.
3. Above running length is only the light length excluding lengths of connectors.
4. The delivered length might be subject to the maximum packing length.

## Double-end Feed

Please refer to the following wiring diagram with double-end feed to run length that is longer than max. running length for single-end feed but less than twice the value.

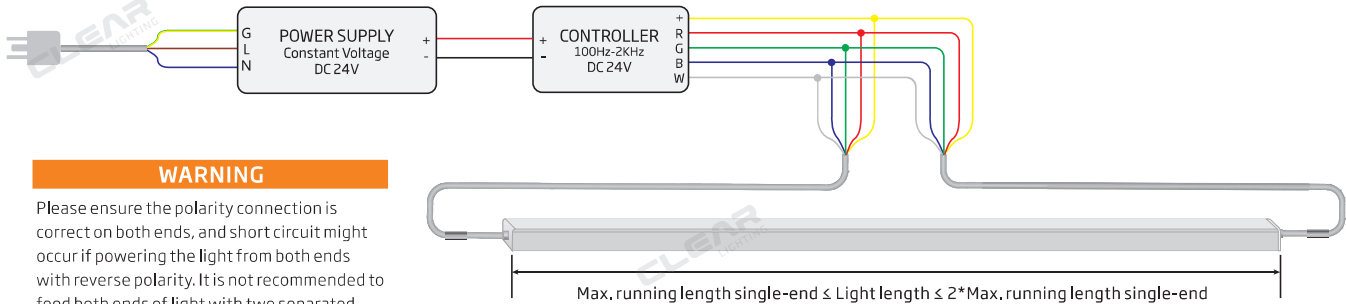

### WARNING

Please ensure the polarity connection is correct on both ends, and short circuit might occur if powering the light from both ends with reverse polarity. It is not recommended to feed both ends of light with two separated power supplies, which would lead to overloading and overheating problem if either power supply is failed.

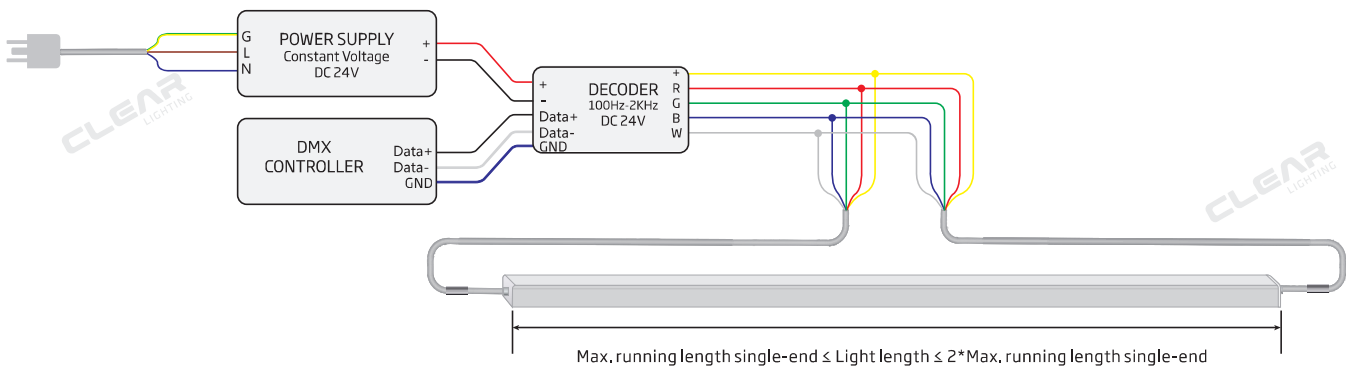

### Light Length:

The length of the longest single light in parallel connection or sum of lights in series connection.

### Cable Length:

The length of an electrical cable between power output end and light input end, and the cables for serial interconnection are inclusive.

### How to Minimize Voltage Drop and Signal Transmission Attenuation

1. It is optimal to position the power supply in the middle of a single light or multiple lines in daisy chain to keep the equivalent cable length on both ends for double-end feed.
2. Please ensure the cable length is not more than the table "Max. Cable Length" according to the half of light length and its wire gauge.
3. Please ensure the light length is less than the table "Max. Running Length Double-end Feed".
4. Shielded Twisted Pair cable is required to be used to connect DMX master controller and decoder, and its length shall be less than 300m.

## Max. Running Length Double-end Feed

Input: DC24V

Connector Type	Snap Connector	Injection-moulded Connector	Dual Injection-moulded Connector
Wire Gauge	20AWG*1+22AWG*4	20AWG*1+22AWG*4	20AWG*1+22AWG*4
C-FR-F15E-15W-Static full loading	10m/32.8ft	10m/32.8ft	10m/32.8ft
C-FR-F15E-15W-Dynamic operating	16m/52.48ft	16m/52.48ft	16m/52.48ft
C-SFR-F15E-15W-Static full loading	16m/52.48ft	16m/52.48ft	/
C-SFR-F15E-15W-Dynamic operating	24m/78.72ft	24m/78.72ft	/

Note:

1. Above conclusion is based on voltage drop testing result of the light with 0.3m (0.98ft) cable only.
2. The maximum running length is based on the designated light in static full loading status exceptionally stated dynamic operating.
3. Above running length is only the light length excluding lengths of connectors.
4. The delivered length might be subject to the maximum packing length.

## F15E Max. Cable Length (PVC)

Input: DC24V

Item Code	Light Length (M)	Cable Length									
		0.32 mm <sup>2</sup>		0.52 mm <sup>2</sup>		0.81 mm <sup>2</sup>		1.32 mm <sup>2</sup>		2.07 mm <sup>2</sup>	
		22AWG		20AWG		18AWG		16AWG		14AWG	
		m	ft	m	ft	m	ft	m	ft	m	ft
C-FR-F15E-15W	1	47.3	155.1	76.8	252.1	119.7	392.6	195.0	639.8	305.8	1003.4
	2	22.0	72.2	35.7	117.2	55.7	182.6	90.7	297.6	142.3	466.7
	3	13.7	44.8	22.2	72.9	34.6	113.5	56.4	185.0	88.4	290.1
	4	9.5	31.0	15.4	50.4	23.9	78.5	39.0	128.0	61.2	200.7
	5			9.6	31.6	15.0	49.3	24.5	80.3	38.4	126.0

## F15E Max. Cable Length (Silicone)

Input: DC24V

Item Code	Light Length (M)	Cable Length									
		0.32 mm <sup>2</sup>		0.52 mm <sup>2</sup>		0.81 mm <sup>2</sup>		1.32 mm <sup>2</sup>		2.07 mm <sup>2</sup>	
		22AWG		20AWG		18AWG		16AWG		14AWG	
		m	ft	m	ft	m	ft	m	ft	m	ft
C-SFR-F15E-15W	1	48.0	157.4	78.0	255.8	121.5	398.5	197.9	649.4	310.4	1018.3
	2	23.8	78.1	38.7	127.0	60.3	197.8	98.2	322.3	154.0	505.4
	3	15.3	50.0	24.8	81.3	38.6	126.7	62.9	206.4	98.7	323.7
	4	11.0	36.2	17.9	58.8	27.9	91.7	45.5	149.4	71.4	234.2
	5			13.9	45.4	21.6	70.8	35.2	115.4	55.1	180.9
	6			11.1	36.4	17.3	56.8	28.2	92.5	44.2	145.0
	7			8.7	28.4	13.5	44.3	22.0	72.2	34.5	113.2
	8			7.2	23.7	11.3	36.9	18.3	60.2	28.8	94.4
	9					9.6	31.6	15.7	51.5	24.6	80.7

Note:

1. Please check the wire gauge of your connector in the table "Max. Running Length".

E.g.,

Single-end feed, C-FR-F15E-15W, 5m light length with 20AWG wire, max. cable length should refer to the corresponding value 9.6m for 5m light length;

Double-end feed, C-FR-F15E-15W, 10m light length with 20AWG wire, max. cable length of each end should refer to the corresponding value 9.6m for half of light length 5m;

2. The above cable lengths are calculated based on 10% allowable voltage drop maximum.