

Side RGB 160/ 240

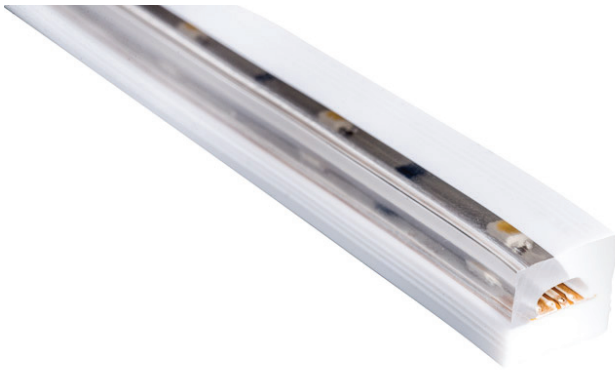

USP's

- Made in Europe
- Unique co-extrusion technology with built in reflection (hollow chamber)
- IP40 (IP68 with liniLED® Cast Joint)
- Very flexible (bend radius > 30 mm)
- Dimmable
- Effective heat dissipation
- Excellent lumen/ Watt ratio
- Available in long lengths
- UV, frost, seawater & chlorine vapour resistant
- Available in various colours
- Extensive range of accessories
- Plug & Play



See page 7 for explanation symbols

liniLED® LED strip Side RGB 160/ 240

The liniLED® Side RGB 160/240 LED strip (IP40/IP68*) is a high quality, flexible LED strip, with a unique co-extrusion technology. The built-in reflection guarantees an optimal light effect from the side. Therefore the liniLED® Side Deco LED strip is ideal for indoor and outdoor usage in round shaped coves, around pillars, etc. In addition to the RGB version, liniLED® Side Deco LED strips are also available in: Ultra Warm White 2400K, Extra Warm White 2700K, Warm White 3000K, Natural White 4000K, Cold White 6500K, Red, Green, Blue and Amber.

* Connect the Side RGB 160/240 LED strip with the liniLED® Side Connector Sets RGB (1 m 11206 or 5 m 11207). Use the liniLED® Side Extension Cord RGB (11211) to extend. Combine with the liniLED® Cast Joint (11533) for waterproof (IP68) usage.

In order to power liniLED® products safely, it is absolutely necessary to operate them with an electronically stabilized power supply protected against short circuits, overload and overheating.

To ease the luminaire/installation approval, electronic control gear for liniLED® products should carry the CE mark. Preferably a controller from the liniLED® Control Range. In Europe, the declarations of conformity must include the following standards: CE: EN 55015, IEC 61547 and IEC 61000-3-2.

Available colours liniLED® Side RGB 160/ 240

Colour	Description
	liniLED® Side RGB 160/ 240

Content

USP's & available colours	1
Product codes & characteristics	2
Product drawings	3
Photometric information	3
Power consumption	4
Power supply	4
Cable selection	5
Maximum cable length	5
Connection diagram	6
Symbols & Disclaimer	7

Product codes & characteristics

Ambient temperature = 25 °C

	RGB	
	RGB 160	RGB 240
Product code [m]	11760	11869
Product characteristics		
Spool length	max. 50 m	
Section length	20 cm	
LED	MULTILED	
Number of LEDs	7 per section / 35 per metre	
Max. connection length	10 m	5 m
Power (24 V DC)	4.8 W/m	7.2 W/m
Power (25 V DC)	5.0 W/m	8.0 W/m
Luminous flux	97 lm/m (R 33, G 62, B 8 lm/m)	168 lm/m (R 55, G 110, B 18 lm/m)
Luminous efficiency	20 lm/W	23 lm/W
Operation voltage	24 V DC	
Max. operation voltage	25 V DC	
Beam angle	55°	
Dimensions	12 x 12 mm	
Dimmable	PWM dimming, 24 V DC Common Anode	
Weight	150 gram per metre	
Material	PVC (chemical resistance www.liniLED.com)	
Expected lifetime	B50/L50 > 50,000 hours @ T _c = 40 °C	B50/L70 > 50,000 hours @ T _c = 40 °C
Degree of protection (IP)	IP40 (IP68 with Cast Joint)	
Degree of protection (IK)	IK08	
Storage temperature	-20 °C .. 55 °C	
Operation temperature	-30 °C .. 55 °C ¹	
Minimal bending radius	30 mm	

¹ Max. connection length between -20 °C and -30 °C is 7 metres (RGB 160) and 3,5 metres (RGB 240).

Product drawings

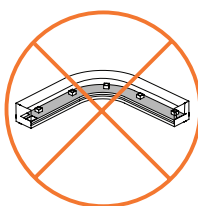
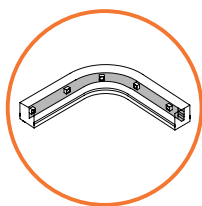
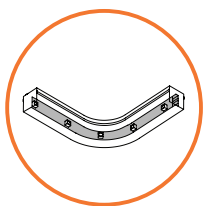

Bending radius

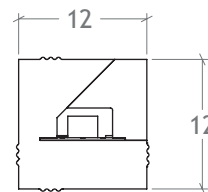

Dimensions

Drawings and dimensions are only to be used as indication, please contact Triolight B.V. for exact measurements and tolerances. Dimensions are displayed in mm.

Photometric information

In the process of lighting design and calculations, the luminous flux and beam angle alone are not enough information to create a representative and realistic calculation or render. Therefore, a complete set of photometric information of the liniLED® LED strips is available on the liniLED® website (www.liniLED.com). The photometric information is available as download for each fixture, found under the downloads tab.

The information on the website is available in two different file formats:

- Eulumdat (*.ldt)
- IES LM-63-1995 (*.ies)

There is one set of photometric files for a one metre length of LED strip and one for a segment length, that corresponds to the cutting length of each LED strip type. Using the one metre data, quick calculations and long lengths can be simulated with photometric software. The segment data allows very detailed simulations, even curved lines can be approached in high detail.

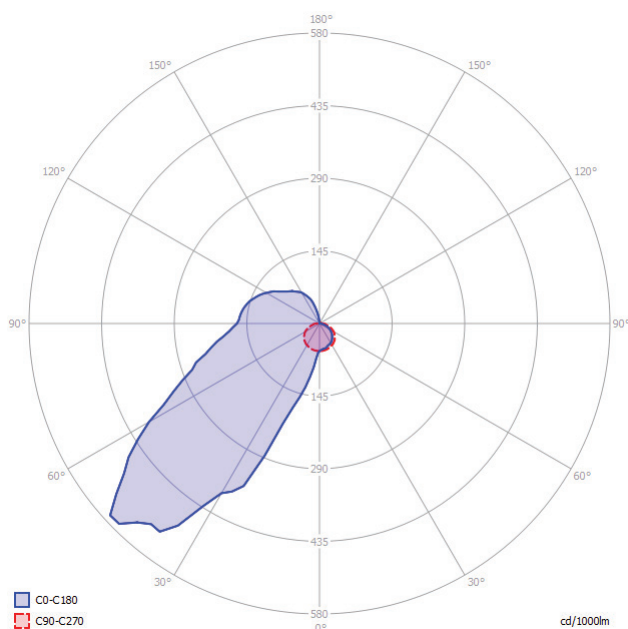

Side RGB 160/ 240 LED strip

This light diagram indicates the beam in the C0-C180 plane (perpendicular to the length direction of the LED strip) and in the plane perpendicular to that, the C90-C270 plane (along the length direction of the LED strip).

Power consumption

To power the liniLED® LED strips and lighting fixtures, a power supply from the liniLED® Power assortment can be selected. Selection of the correct power supply must be done by taking the total requested power and the environment into account.

The total power consumption can be calculated by summing the requested power of all connected products. To calculate the power consumption of a single length of LED strip, use the equation below. The typical equation is valid if the product is supplied by a 24 V DC constant voltage power supply. If the output voltage of a power supply is increased, the power consumption will increase with the same ratio and needs to be corrected by using the optional part of the equation found between brackets.

$$P_{STRIP} = P_{PRODUCT} \times X_{LENGTH} \times 110\% \left[\times \frac{U_{SUPPLY}}{24} \right]$$

- P_{STRIP}** Calculated power consumption of one LED strip in Watt
- $P_{PRODUCT}$** Typical power consumption in Watt per metre of the selected LED strip
This value can be found under 'Product characteristics' on page 2
- X_{LENGTH}** Length of the connected LED strip in metres
- 110%** Safety margin to buffer differences over all production batches

Optional:

- U_{SUPPLY}** Set supply voltage of the power supply in Volt
- 24** Nominal supply voltage of liniLED® in Volt

Power supply

The liniLED® Power Supplies are available for different environments. For usage in normal dry environments (where the use of an open-frame supply is omitted) the standard liniLED® IP20 Power Supplies can be used. If the environment requires special protection against moisture or even protection against submersion, the selection of IP64, IP65 or IP67 power supplies can be used depending on the environment. All of the IP65 and IP67 Power Supplies are SELV equivalent and can be used if SELV equivalent power supplies are required.

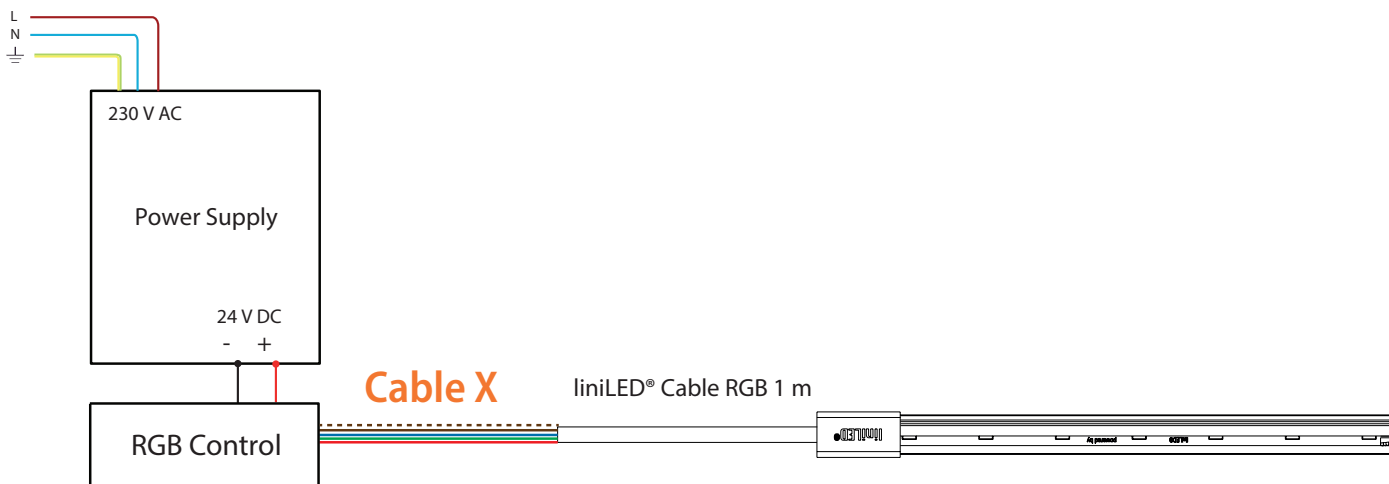

Visualisation cable calculation

Cable selection

The liniLED® LED strips need a minimum voltage on the beginning of the LED strip to function according to the specifications. The table below gives an indication of the maximum cable length based on the cable thickness and power supply voltage. The connection between the cable and LED strip is with a liniLED® Side connector with a cable length of 1m (Product code: 11206).

In case the required length is larger than the length mentioned in this table, the supply voltage is different or if a detailed wire plan with branches is planned, please contact your distributor for a detailed cable calculation.

Cable X information	LED strip length	Max. cable length RGB	
		@ 24 V DC	@ 25 V DC
liniLED® cable 0.086 Ω/m 0.035 Ω/m	1 m	62.17 m	120.47 m
	5 m	11.47 m	23.13 m
	10 m	5.14 m	10.97 m
4 x 0.75 mm² 0.023 Ω/m 0.023 Ω/m	1 m	132.57 m	256.89 m
	5 m	24.47 m	49.33 m
	10 m	10.95 m	23.39 m
4 x 1.00 mm² 0.018 Ω/m 0.018 Ω/m	1 m	176.25 m	341.54 m
	5 m	32.53 m	65.59 m
	10 m	14.56 m	31.09 m
4 x 1.50 mm² 0.012 Ω/m 0.012 Ω/m	1 m	265.14 m	513.78 m
	5 m	48.93 m	98.66 m
	10 m	21.91 m	46.77 m
4 x 2.50 mm² 0.007 Ω/m 0.007 Ω/m	1 m	441.27 m	855.08 m
	5 m	81.44 m	164.20 m
	10 m	36.46 m	77.84 m

Cable X information	LED strip length	Max. cable length RGB	
		@ 24 V DC	@ 25 V DC
5 x 0.75 mm² 0.023 Ω/m 0.012 Ω/m	1 m	205.55 m	398.32 m
	5 m	37.94 m	76.49 m
	10 m	16.98 m	36.26 m
5 x 1.00 mm² 0.018 Ω/m 0.009 Ω/m	1 m	273.30 m	529.59 m
	5 m	50.44 m	101.70 m
	10 m	22.58 m	48.21 m
5 x 1.50 mm² 0.012 Ω/m 0.006 Ω/m	1 m	411.11 m	796.65 m
	5 m	75.87 m	152.98 m
	10 m	33.97 m	72.52 m
5 x 2.50 mm² 0.007 Ω/m 0.004 Ω/m	1 m	684.22 m	1325.86 m
	5 m	126.28 m	254.60 m
	10 m	56.53 m	120.70 m

Maximum cable length

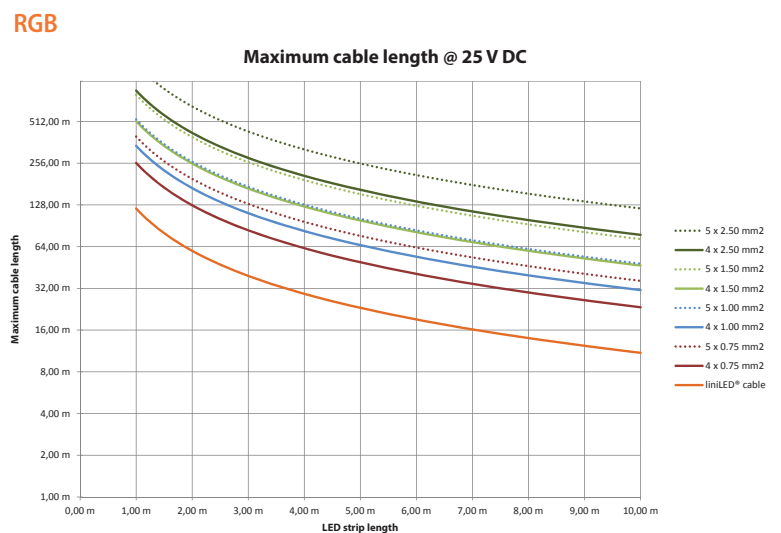
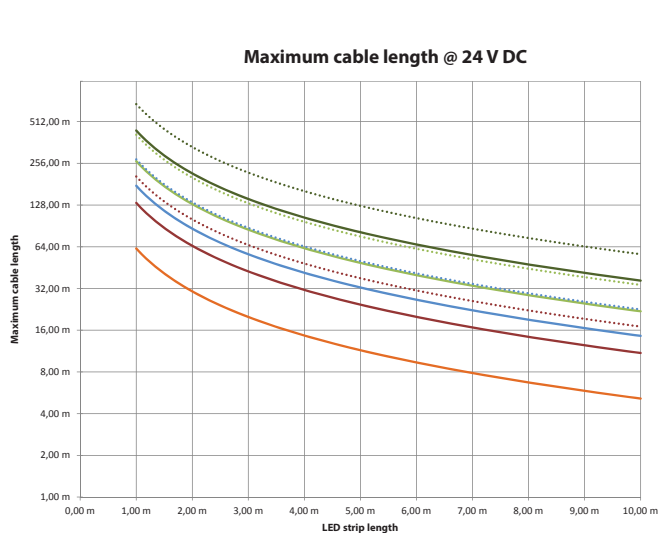

Connection diagram

The LED strip can be connected with a connector set as shown in the diagram.

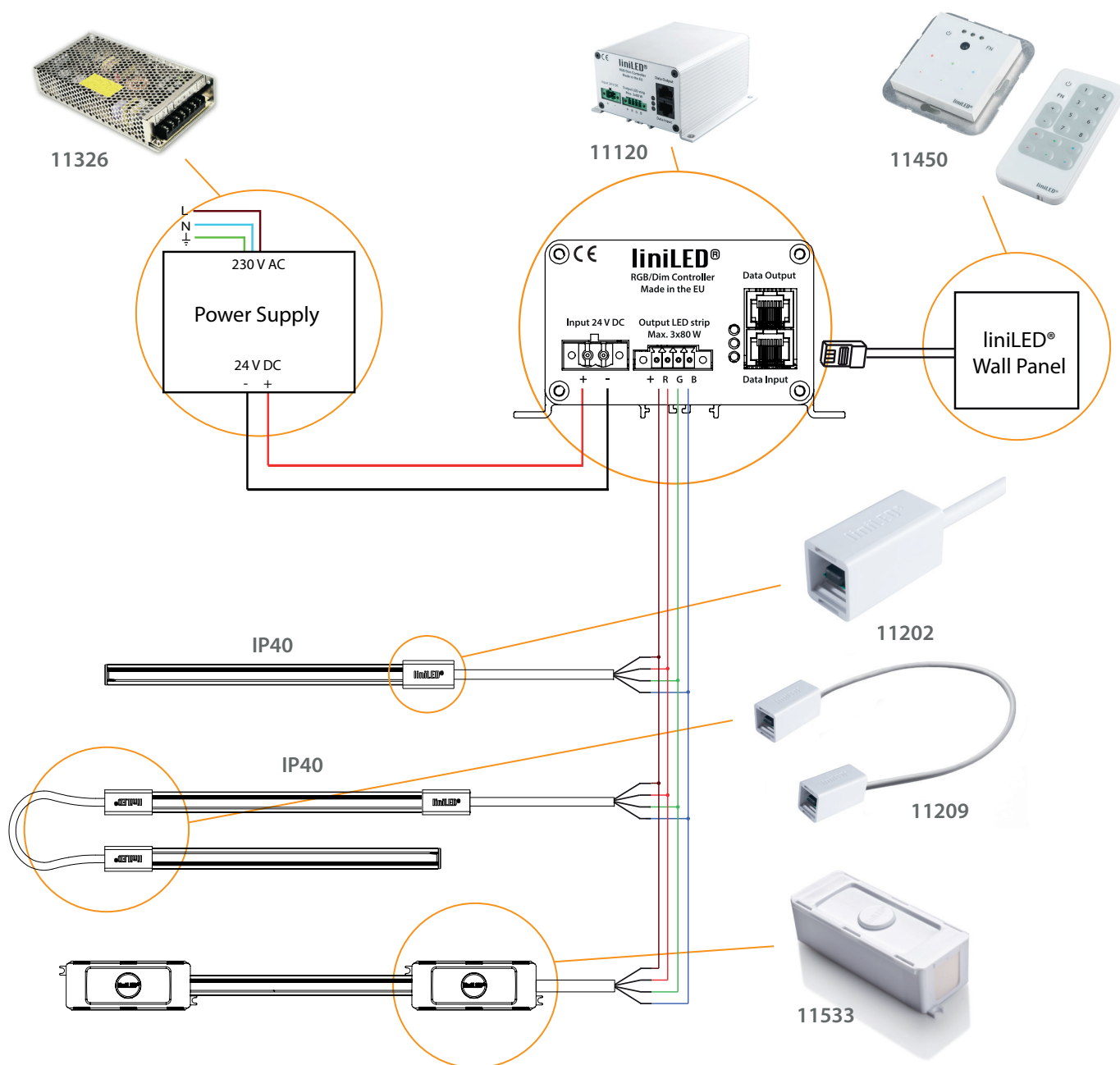

Symbols



Manufacturer's declaration that the product meets the applicable EC directives.



Suitable for mounting on all surfaces and suitable to cover with insulating material.



Passed glow wire test at 850 degrees Celsius.
Global European regulations specify 650 degrees Celsius by default.



Restriction of Hazardous Substances (RoHS): product complies with the RoHS directive and each homogeneous material does not exceed the limits for the materials mentioned under the RoHS directive (Pb, Hg, Cd, Cr⁶⁺, PBB and PBDE).



IP68 in combination with the liniLED® Top Connector Set and the liniLED® IP68 Kit, otherwise IP40.



Protected against impact energy of 5 joules.



Bending of the LED strip is possible with a radius of ≥ 30 millimetres in the specified direction.



Electrical appliance class III: this product is designed to be supplied from an extra-low voltage (≤ 60.0 V DC or ≤ 42.4 V AC).



Product is resistant against ultraviolet (UV) light or sunlight.
Non-UV resistant products can degrade or discolor fast when exposed to UV light.



Product can be cleaned with normal cleaning agents as specified under '*LED strip chemical resistance*'.



This product can be stored and used below 0 degrees Celsius. Verify the minimum storage and operation temperature under '*Product characteristics*' for the lowest temperature allowed.



This product can be applied in seawater and its environment. Elements in seawater will have no harmful effect on the product. For chemical specifications see '*LED strip chemical resistance*'. Verify the IP rating for proper use.



This product can be applied inside swimming pools and their environment. Elements in the water -for water treatment- will have no harmful effect on the product. For chemical specifications of these elements '*LED strip chemical resistance*'. Verify the IP rating for proper use.



This product needs to be disposed or separated from normal household waste so it can be recycled.

Disclaimer

The published information is checked to be as accurate as possible, however Triolight B.V., or any reseller of liniLED® cannot be held liable for any damages resulting from errors or outdated information. Triolight B.V. reserves the right to modify the information without informing the costumers. When this document is printed or downloaded, please check for the latest version on the internet, the most up to date information will be published on www.liniLED.com. This product should not be used in applications, devices or systems where incorrect operation of the product may result in personal injury (includes emergency lighting) without written permission from the board of Triolight B.V.. If nevertheless used in such applications, devices or systems Triolight B.V. cannot be held liable for any resulting injury.