

Flexglo™ F2219S DMX Pixel Light (Silicone)

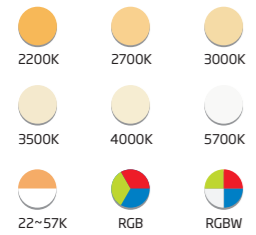

Certification Mark		
Test Standard/Directive	UL2108 Class 2	CE-LVD
Certificate Serial Number	E360029	LCS200512024BS



Ambient Working Temperature
 12W/m -40~55°C /-40~131°F
 15W/m -40~45°C /-40~113°F

Ambient Installation Temperature
 -40 ~ 50°C /-40~122°F

Storage Temperature
 -40 ~ 60°C /-40~140°F

Max. Mounting Surface Temperature
 85°C /185°F

Constant Current
 DC24V

specified in the non-working state of light.

C-SFR-F2219S-VB

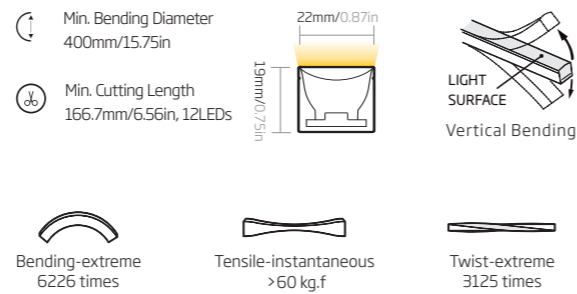

Warning: Extreme Destructive Tests in laboratory only, and it's forbidden to operate in practice.

Note:

- The illuminated light length shall be an integral multiple of min. cutting length.
- The waterproof reliability of the lighting fixture depends on the IP rating of connector (see details on page ***), and please make sure connector is properly assembled before installation. The highest IP rating we can achieve is IP68.

Item Code

C	SFR	F2219S6	VB	24CC	30K	WM	84	80	15W	166.7		
Company	Material	Product Series	Bending Direction	Voltage & Circuit Type	Color/CCT	Base & Lighting Surface	LEDs Qty/m	CRI	Power/m	Min. Cutting Length (mm)		
Clear	SFR= Silicone Flex Ribbon	F2219S= DMX Pixel Light	VB= Vertical Bending	DC24V & Constant Current	RGB	WM= White & Milky	72	/	12W	166.7		
					RGBW (27K)= RGB& 2700K				84		80	
					RGBW (30K)= RGB& 3000K							15W
					RGBW (40K)= RGB & 4000K							
					22K=2200K 27K=2700K 30K=3000K 35K=3500K 40K=4000K 57K=5700K			12W				
					22~57K= 2200~5700K							

Feature

Flexglo™ F2219S DMX Pixel Light (Silicone) are the products that each segment is individually addressable so that you can achieve myriad color changing or animation effects via compatible controller. It is a DMX protocol product with built-in IC chip of UCS512CN, available in RGBW. Thanks to the excellent weatherproof and UV-resistant performance of silicone material, it features a wide ambient working temperature range of -40-55 °C, especially suitable for harsh environment application.

Combined with the adoption of the DryWire™ technology, the IP68 Injection-moulded Connector is engineered for outdoor use, owing to its elegant appearance and strong adhesiveness acquired by the liquid silicone injection workmanship.

This product features a ultra long lifespan in outdoor application by leveraging other ClearTech™ such as the PinBoost™ technology enhancing physical reliability of light engine, the TwinFlex™ technology improving the conductivity and optimizing heat dissipation performance, the C-Mask™ technology making the light body self-cleaning and anti-UV and enabling consistent illumination.

Electrical Parameter

Category				
Voltage (V)	24	24	24	24
Current (mA/m)	625.0	500.0	500.0	625.0
Power (W/m)	15	12	12	15
Circuit Type	CC	CC	CC	CC
LED Type	2835	2835	5050	5050
LEDs Qty/m	84	84	72	72
LEDs Qty/unit	14	14	12	12
Unit/m (Pixel Qty/m)	6 (UCS512CN)	6 (UCS512CN)	6 (UCS512CN)	6 (UCS512CN)
Min. Cutting Length (mm)	166.7	166.7	166.7	166.7
Min. Cutting Length (in)	6.56	6.56	6.56	6.56

Optical Parameter

Item Code	Finished Product						LED	
	Color/CCT	Wavelength/CCT Tolerance	Color Tolerance	CRI	Lumen/m	Lumen/ft	Color Tolerance	CRI
C-SFR-F2219S6-VB-24CC-22K-WM-84-80-15W-166.7	2200K	2238±82K	<5SDCM	80	600	183	<2.3SDCM	82~87
C-SFR-F2219S6-VB-24CC-27K-WM-84-80-15W-166.7	2700K	2725±115K	<5SDCM	80	650	198	<2.3SDCM	82~87
C-SFR-F2219S6-VB-24CC-30K-WM-84-80-15W-166.7	3000K	3045±140K	<5SDCM	80	700	213	<2.3SDCM	82~87
C-SFR-F2219S6-VB-24CC-35K-WM-84-80-15W-166.7	3500K	3465±170K	<5SDCM	80	700	213	<2.3SDCM	82~87
C-SFR-F2219S6-VB-24CC-40K-WM-84-80-15W-166.7	4000K	3985±225K	<5SDCM	80	700	213	<2.3SDCM	82~87
C-SFR-F2219S6-VB-24CC-57K-WM-84-80-15W-166.7	5700K	5665±355K	<5SDCM	80	650	198	<2.3SDCM	82~87
C-SFR-F2219S6-VB-24CC-22~57K-WM-84-12W-166.7	2200K	2238±82K	<5SDCM	80	260	79	<2.3SDCM	82~87
	5700K	5665±355K	<5SDCM	80	320	98	<2.3SDCM	82~87
C-SFR-F2219S6-VB-24CV-RGB-WM-72-12W-166.7	Red	618-624nm	N/A	N/A	75	23	<3nm	N/A
	Green	522-530nm	N/A	N/A	205	63	<3nm	N/A
	Blue	468-474nm	N/A	N/A	40	12	<3nm	N/A
	R+G+B	R+G+B	N/A	N/A	320	98	N/A	N/A
C-SFR-F2219S6-VB-24CC-RGBW(27K)-WM-72-15W-166.7	Red	618-624nm	N/A	N/A	75	23	<3nm	N/A
	Green	522-530nm	N/A	N/A	205	63	<3nm	N/A
	Blue	468-474nm	N/A	N/A	40	12	<3nm	N/A
	White	2725±115K	<5SDCM	80	180	55	<2.3SDCM	82~87

Flexglo™ F2219S DMX Pixel Light (Silicone)

Optical Parameter

Item Code	Finished Product						LED	
	Color/CCT	Wavelength/ CCT Tolerance	Color Tolerance	CRI	Lumen/m	Lumen/ft	Color Tolerance	CRI
C-SFR-F2219S6-VB-24CC-RGBW(30K)-WM-72-15W-166.7	Red	618-624nm	N/A	N/A	75	23	<3nm	N/A
	Green	522-530nm	N/A	N/A	205	63	<3nm	N/A
	Blue	468-474nm	N/A	N/A	40	12	<3nm	N/A
	White	3045±140K	<5SDCM	80	180	55	<2.3SDCM	82~87
C-SFR-F2219S6-VB-24CC-RGBW(40K)-WM-72-15W-166.7	Red	618-624nm	N/A	N/A	75	23	<3nm	N/A
	Green	522-530nm	N/A	N/A	205	63	<3nm	N/A
	Blue	468-474nm	N/A	N/A	40	12	<3nm	N/A
	White	3985±225K	<5SDCM	80	180	55	<2.3SDCM	82~87

Note:

1. CCT Tolerance refers to target CCT and tolerance (ANSI C78.377).
2. Color Tolerance refers to CLEAR standard for finished product and LED.







Max. Running Length Input: DC24V

	
Type	Silicone Injection-moulded Connector
IP Rating	IP68
Item Code	Single-end Feed
C-SFR-F2219S6-DMX-12W-Static Full loading	10m/32.8ft
C-SFR-F2219S6-DMX-12W-Dynamic Operating	15m/49.2ft
C-SFR-F2219S6-DMX-15W-Static Full loading	8m/26.2ft
C-SFR-F2219S6-DMX-15W-Dynamic Operating	12m/39.4ft







Note:

1. Above conclusion is based on voltage drop testing result of the light with 0.3m (0.98ft) cable only.
2. The maximum running length is based on the light in static full loading status exceptionally stated dynamic operating.
3. Above running length is only the light length excluding lengths of connectors. **Please refer to page ***** for exact dimension of connector.
4. The delivery length might be subject to the maximum packing length. **Please refer to page ***** for details.

F2219S Connector (Silicone)

Type/IP Rating	Bending Direction	Front Connector End	Front Connector Side from Left	Front Connector Side from Right	Front Connector Bottom	Seamless Middle Connector & Power Feed	Middle Connector & Power T-feed	Jumper	End Cap
Silicone Injection-moulded Connector	VB					N/A			
IP68		F2219S-VB-SIM/FC-01/02-E-0.3m/1m/3m/5m/10m	F2219S-VB-SIM/FC-01/02-SL-0.3m/1m/3m/5m/10m	F2219S-VB-SIM/FC-01/02-SR-0.3m/1m/3m/5m/10m	F2219S-VB-SIM/FC-01/02-B-0.3m/1m/3m/5m/10m	N/A	F2219S-VB-SIM/MC-PTF-0.3m/1m/3m	F2219S-VB-SIM/JU-0.3m/1m	F22-SIM/EC

F2219 Mounting Profile

Picture	Name/Item Code	Installation Way
	Serrated Aluminum Profile F2219-SA/PL-500/1000/2000mm	     

Flexglo™ F2219S DMX Wiring Diagram

1. Please use a constant voltage power supply with corresponding output voltage, and rated wattage of the power supply shall be 25% more than the actual power consumption of light to increase its life expectancy;

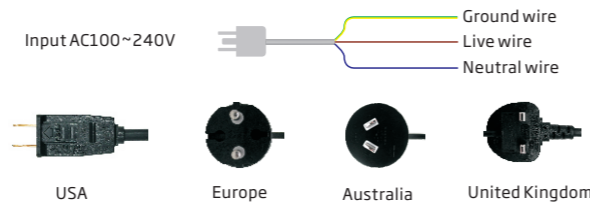

2. This wiring diagram is using the mains of AC230V with brown and blue wires as an example, and please connect with the corresponding live and neutral wires for other mains electricity;

3. Types of standard plugs are optional if power cord is purchased from CLEAR.

4. Adopted UCS512CN IC inside, it is compatible with DMX512 controller at a baud rate of 250Kbps.

4.1 Without signal amplifier and termination resistor, max. signal transmission distance of DMX controller is 300m including the light length;

4.2 If any signal interference or attenuation occurs, in the case of no signal amplifier, 120Ω termination resistor[®] should be added

to achieve smooth and long-distance signal transmission up to 600m from DMX controller output to the light end;

4.3 When DMX controller is far away from light, combined with signal amplifier, the signal can transmit further. Please be aware the max. distance between DMX512 controller and signal amplifier is 300m, and the extended signal transmission distance depends on the specification of signal amplifier.

5. DMX512 controller can run max. 512 channels each port, and for each pixel, 4 channels are needed for RGBW, 3 channels for RGB, 2 channels for Dynamic light, and 1 channel for Monochrome. The rest parts beyond control should work with other ports of controller once the total occupied channels of light exceed 512.

6. DMX controller is used for signal transmission only, and the independent power supply is required to power up lights. Please refer to the following wiring diagrams for your project. To enable address coding, the green ADR wire between lights must be connected correctly.

Single-end Feed

Light Length:

The length of the longest single light in parallel connection or sum of lights in series connection.

Cable Length:

The length of an electrical cable between power output end and light input end, and the cables for serial interconnection are inclusive.

How to Minimize Voltage Drop and Signal Transmission Attenuation

1. Please ensure the cable length is not more than the table "Max. Cable Length" according to light length and its wire gauge.
2. Please ensure the light length is less than the cable "Max. Running Length Single-end Feed".
3. 2 wires of Shielded Twisted Pair cable is required to be used to connect DMX controller and signal amplifier in the distance of max.300m, and wire gauge 20AWG or above is more recommended.

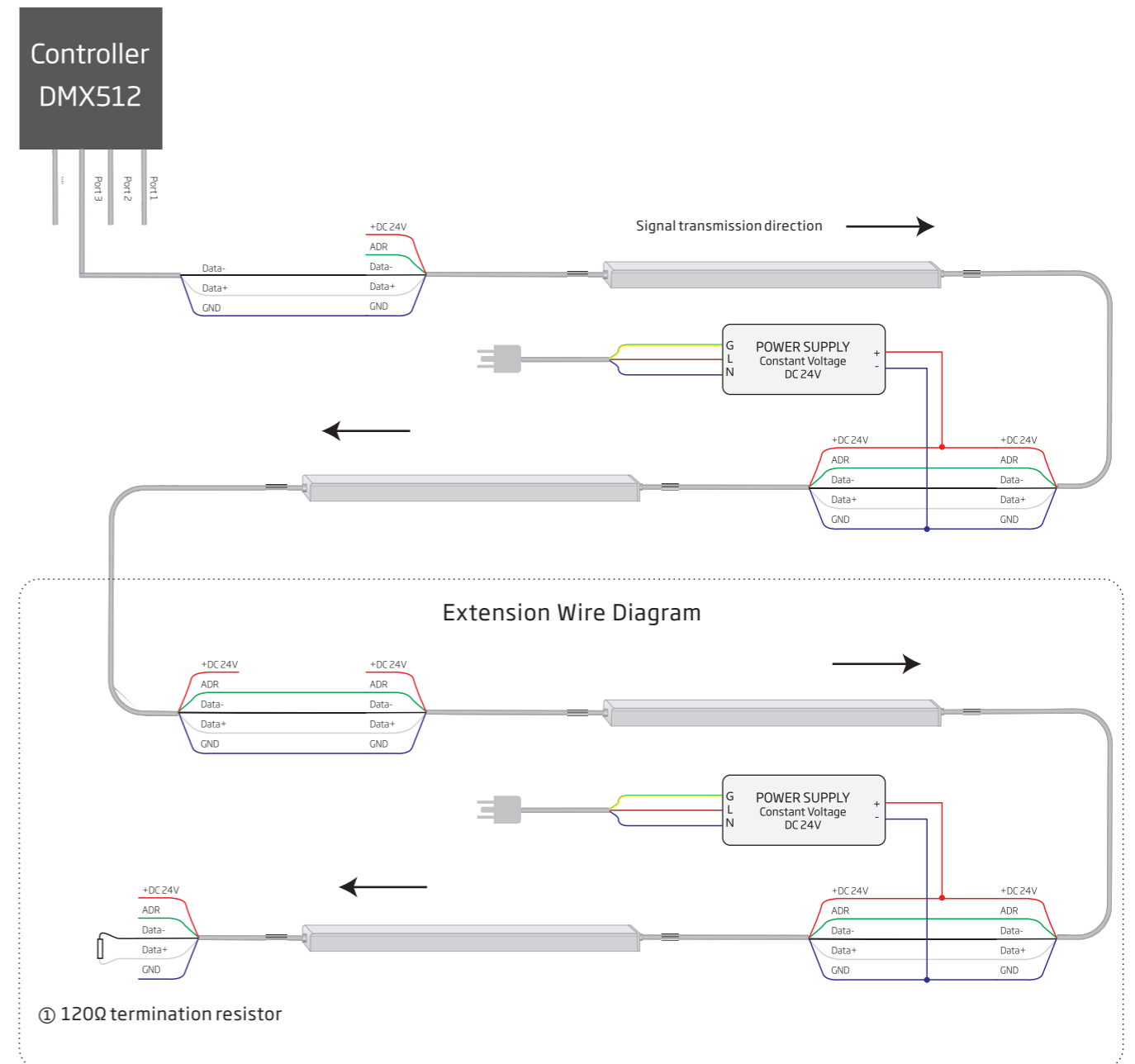

Max. Running Length Single-end Feed

Input: DC24V

Connector Type	Injection-moulded Connector
Wire Gauge	20AWG*2+22AWG*3
C-SFR-F2219S6-DMX-12W-Static Full loading	10m/32.8ft
C-SFR-F2219S6-DMX-12W-Dynamic Operating	15m/49.2ft
C-SFR-F2219S6-DMX-15W-Static Full loading	8m/26.2ft
C-SFR-F2219S6-DMX-15W-Dynamic Operating	12m/39.4ft

Note:

1. Above conclusion is based on voltage drop testing result of the light with 0.3m (0.98ft) cable and max. pixel output of international standard DMX512 controller.
2. The maximum running length is based on the designated light in static full loading status exceptionally stated dynamic operating.
3. Above running length is only the light length excluding lengths of connectors. Please refer to page *** for exact dimension of connector.
4. The delivered length might be subject to the maximum packing length. Please refer to page *** for details.

Double-end Feed

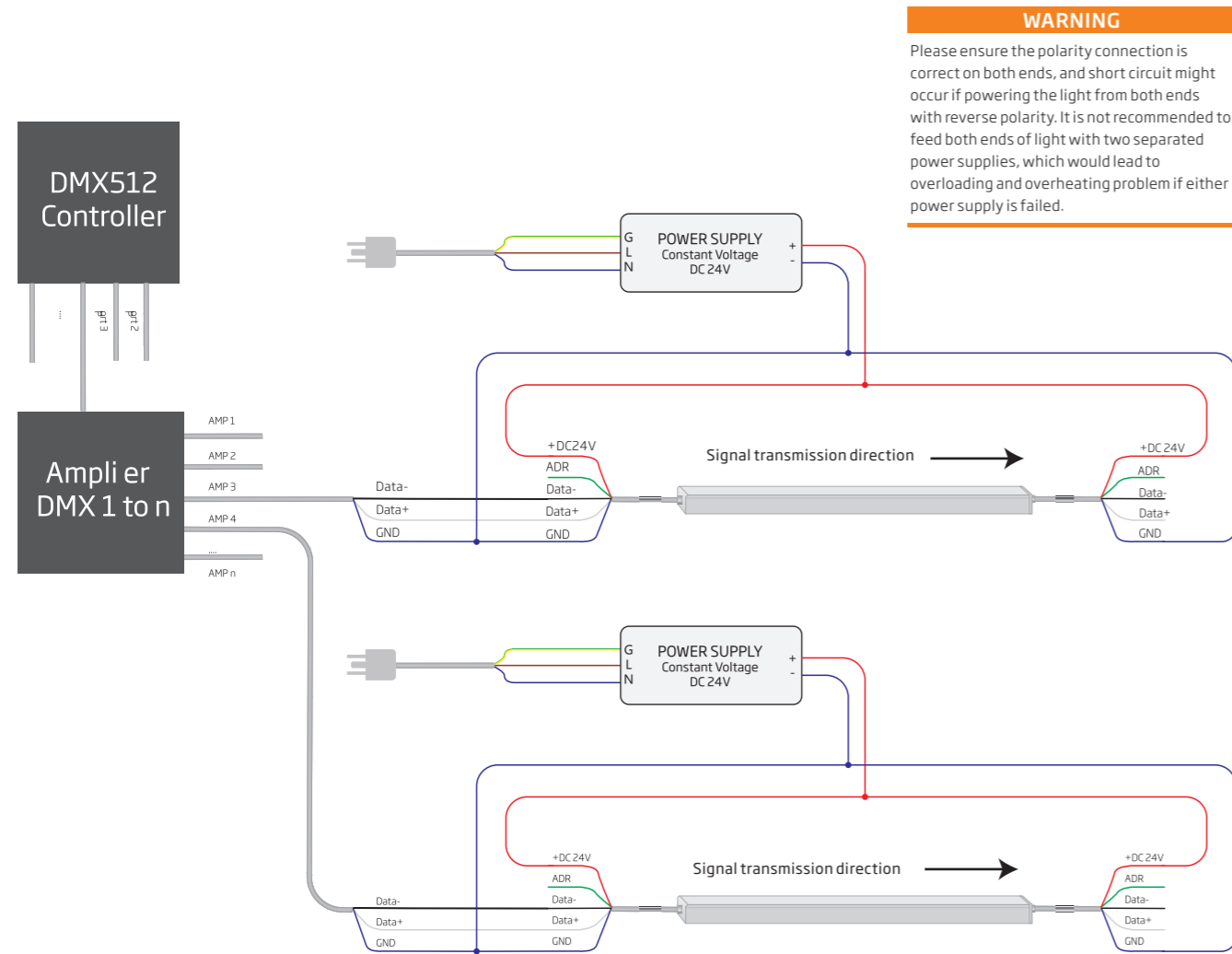

Please refer to the following wiring diagram with double-end feed to run length that is longer than max. running length for single-end feed but less than twice the value.

Light Length:

The length of the longest single light in parallel connection or sum of lights in series connection.

Cable Length:

The length of an electrical cable between power output end and light input end, and the cables for serial interconnection are inclusive.

How to Minimize Voltage Drop and Signal Transmission Attenuation

1. It is optimal to position the power supply in the middle of a single light or multiple lines in daisy chain to keep the equivalent cable length on both ends for double-end feed.
2. Please ensure the cable length is not more than the table "Max. Cable Length" according to the half of light length and its wire gauge.
3. Please ensure the light length is less than the table "Max. Running Length Double-end Feed".
4. 2 wires of Shielded Twisted Pair cable is required to be used to connect DMX controller and signal amplifier in the distance of max.300m, and wire gauge 20AWG or above is more recommended.

Max. Running Length Double-end Feed

Input: DC24V

Connector Type	Injection-moulded Connector
Wire Gauge	20AWG*2+22AWG*3
C-SFR-F2219S6-DMX-12W-Static Full loading	20m/65.6ft
C-SFR-F2219S6-DMX-12W-Dynamic Operating	30m/98.4ft
C-SFR-F2219S6-DMX-15W-Static Full loading	16m/52.5ft
C-SFR-F2219S6-DMX-15W-Dynamic Operating	24m/78.7ft

Note:

1. Above conclusion is based on voltage drop testing result of the light with 0.3m (0.98ft) cable and max. pixel output of international standard DMX512 controller.
2. The maximum running length is based on the designated light in static full loading status exceptionally stated dynamic operating.
3. Above running length is only the light length excluding lengths of connectors. Please refer to page *** for exact dimension of connector.
4. The delivered length might be subject to the maximum packing length. Please refer to page *** for details.

F2219S Max. Cable Length (Silicone)

Input: DC24V

Item Code	Light Length (M)	Cable Length									
		0.32 mm ²		0.52 mm ²		0.81 mm ²		1.32 mm ²		2.07 mm ²	
		22AWG		20AWG		18AWG		16AWG		14AWG	
		m	ft	m	ft	m	ft	m	ft	m	ft
C-SFR-F2219S-12W-(RGB, W+WW)	1	20.0	65.6	33.0	108.2	51.0	167.3	83.0	272.2	131.0	429.7
	2	10.0	32.8	16.0	52.5	25.5	83.6	41.5	136.1	65.5	214.8
	3	6.5	21.3	11.0	36.1	17.0	55.8	27.5	90.2	43.5	142.7
	4	5.0	16.4	8.0	26.2	12.5	41.0	20.5	67.2	32.5	106.6
	5	4.0	13.1	6.5	21.3	10.0	32.8	16.5	54.1	26.0	85.3
	6	3.0	9.8	5.5	18.0	8.5	27.9	13.5	44.3	21.5	70.5
	7			4.5	14.8	7.0	23.0	11.5	37.7	18.5	60.7
	8			4.0	13.1	6.0	19.7	10.0	32.8	16.0	52.5
	9			3.5	11.5	5.5	18.0	9.0	29.5	14.5	47.6
	10			3.0	9.8	5.0	16.4	8.0	26.2	13.0	42.6
C-SFR-F2219S-15W-(W,RGBW)	1	15.5	50.8	25.0	82.0	39.0	127.9	64.0	209.9	100.0	328.0
	2	7.5	24.6	12.5	41.0	19.5	64.0	32.0	105.0	50.0	164.0
	3	5.0	16.4	8.0	26.2	13.0	42.6	21.0	68.9	33.0	108.2
	4	3.5	11.5	6.0	19.7	9.5	31.2	16.0	52.5	25.0	82.0
	5	3.0	9.8	5.0	16.4	7.5	24.6	13.0	42.6	20.0	65.6
	6			4.0	13.1	6.5	21.3	10.5	34.4	16.5	54.1
	7			3.5	11.5	5.5	18.0	9.0	29.5	14.0	45.9
	8			3.0	9.8	4.5	14.8	8.0	26.2	12.5	41.0

Note:

1. Please check the wire gauge of your connector in the table "Max. Running Length".
E.g., Single-end feed, C-SFR-F2219S-15W, 5m light length with 20AWG wire, max. cable length should refer to the corresponding value 5m for 5m light length;
Double-end feed, C-SFR-F2219S-15W, 10m light length with 20AWG wire, max. cable length of each end should refer to the corresponding value 5m for half of light length 5m;
2. The above cable lengths are calculated based on 10% allowable voltage drop maximum.
3. To avoid signal degradation, please ensure the data cable length is within the maximum signal transmission distance according to the specification of controller/signal amplifier.