

Flexglo™ F22E RGBW Light (Silicone)

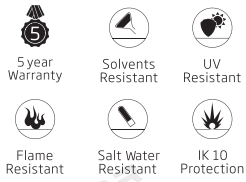

Certification Mark		CE
Test Standard/Directive	UL2108 Class 2	CE-EMC
Certificate Serial Number	20180801-E360029	SZEM1712012372LMV
Report Reference	E360029-20130322	SZEM171201237201

Ambient Working Temperature $\leq 15W$ -40 ~ 45°C / -40 ~ 113°F

Ambient Working Temperature $\leq 12W$ $\geq -40^{\circ}C$ / -40°F

Storage Temperature -40 ~ 60°C / -40 ~ 140°F

Max. Mounting Surface Temperature 85°C / 185°F

Ambient Installation Temperature -40 ~ 50°C / -40 ~ 122°F

Constant Voltage DC24V

specified in the non-working state of light.

C-SFR-F22E-VB



C-SFR-F22E-VB-24CV-RGBW(27K)-WM-84-80-15W-83.3

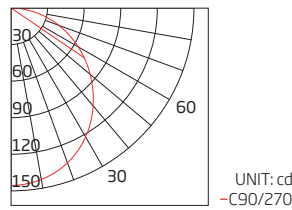

Min. Bending Diameter 300mm/11.81in

Min. Cutting Length 83.3mm/3.28in
7LEDs

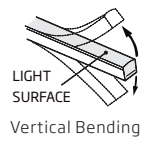
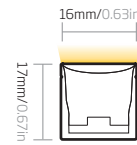

Bending-extreme 8902 times

Tensile-instantaneous >100 kg.f

Twist-extreme 5433 times

AVERAGE BEAM ANGLE (50%): 113.6°

Warning: Extreme Destructive Tests in laboratory only, and it's forbidden to operate in practice.

C-SFR-F22E-HB

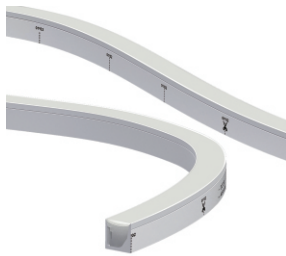

C-SFR-F22E-HB-24CV-RGBW(30K)-WM-84-15W-100-RGBW

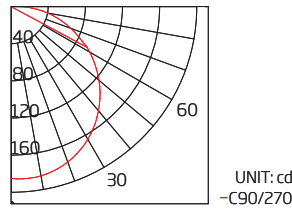

Min. Bending Diameter 300mm/11.81in

Min. Cutting Length 83.3mm/3.28in
7LEDs

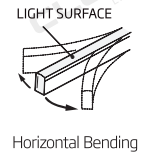
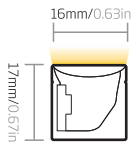

Bending-extreme 2234 times

Tensile-instantaneous >100 kg.f

Twist-extreme 6760 times

AVERAGE BEAM ANGLE(50%):113.7

Warning: Extreme Destructive Tests in laboratory only, and it's forbidden to operate in practice.

Note:

1. The illuminated light length shall be an integral multiple of min. cutting length.
2. The waterproof reliability of the lighting fixture depends on the IP rating of connector, and please make sure connector is properly assembled before installation. The highest IP rating we can achieve is IP68.

Item Code

C	SFR	F22E	VB	24CV	RGBW (27K)	WM	84	80	15W	83.3
Company	Material	Product Series	Bending Direction	Voltage & Circuit Type	Color	Base & Lighting Surface	LEDs Qty/m	CRI	Power/m	Min. Cutting Length (mm)
Clear	SFR= Silicone Flex Ribbon	F22E=RGBW	VB= Vertical Bending HB= Vertical Bending	DC24V & Constant Voltage	RGBW(27K)= RGB& 2700K RGBW(30K)= RGB & 3000K RGBW(40K)= RGB & 4000K	WM= White & Milky	84	80	15W	83.3

Feature

Flexglo™ F22E RGBW Light (Silicone) is a color changing product with qua-chip SMD5050 RGBW LEDs as light source, an ideal product for project where premium LED is required. RGBW color changing is achievable via a 4 channel PWM controller or any compatible DMX-512 controller, and 2700K and 4000K in white color are optional. Thanks to the excellent weatherproof and UV-resistant performance of silicone material, it features a wide ambient working temperature range of -40-55 °C, especially suitable for harsh environment application.

Combined with the adoption of the DryWire™ technology, the IP68 Injection-moulded Connector is engineered for outdoor use, owing to its elegant appearance and strong adhesiveness acquired by the liquid silicone injection workmanship.

This product features a ultra long lifespan in outdoor application by leveraging other ClearTech™ such as the PinBoost™ technology enhancing physical reliability of light engine, the TwinFlex™ technology improving the conductivity and optimizing heat dissipation performance, the C-Mask™ technology making the light body self-cleaning and anti-UV and enabling consistent illumination.

Electrical Parameter

Category	C-SFR-F22E-VB	C-SFR-F22E-HB
Voltage (V)	24	24
Current (mA/m)	625.0	625.0
Power (W/m)	15	15
Circuit Type	CV	CV
LED Type	5050	5050
LEDs Qty/m	84	84
LEDs Qty/unit	7	7
Unit/m	12	12
Min. Cutting Length (mm)	83.3	83.3
Min. Cutting Length (in)	3.28	3.28

Optical Parameter

Item Code	Finished Product						LED	
	Color	Wavelength/CCT	Color Tolerance	CRI	Lumen/m	Lumen/ft	Color Tolerance	CRI
C-SFR-F22E-VB-24CV-RGBW(27K)-WM-84-15W-83.3	Red	618-624nm			90lm	27lm	< 3nm	
	Green	522-530nm			240lm	73lm	< 3nm	
	Blue	468-474nm			40lm	12lm	< 3nm	
C-SFR-F22E-VB-24CV-RGBW(30K)-WM-84-15W-83.3	2700K	2725±145K	<5SDCM	80	240lm	73lm	<2.3SDCM	82~87
	Red	618-624nm			90lm	27lm	< 3nm	
	Green	522-530nm			240lm	73lm	< 3nm	
C-SFR-F22E-VB-24CV-RGBW(40K)-WM-84-15W-83.3	Blue	468-474nm			40lm	12lm	< 3nm	
	3000K	3045±140K	<5SDCM	80	240lm	73lm	<2.3SDCM	82~87
	Red	618-624nm			90lm	27lm	< 3nm	
C-SFR-F22E-VB-24CV-RGBW(40K)-WM-84-15W-83.3	Green	522-530nm			240lm	73lm	< 3nm	
	Blue	468-474nm			40lm	12lm	< 3nm	
	4000K	3985±275K	<5SDCM	80	240lm	73lm	<2.3SDCM	82~87

Note:

1. CCT Tolerance refers to target CCT and tolerance (ANSI C78.377).
2. Color Tolerance refers to CLEAR standard for finished product and LED.

Flexglo™ F22E RGBW Light (Silicone)

Optical Parameter

Item Code	Finished Product						LED	
	Color	Wavelength/CCT	Color Tolerance	CRI	Lumen/m	Lumen/ft	Color Tolerance	CRI
C-SFR-F22E-HB-24CV-RGBW(27K)-WM-84-15W-83.3	Red	618-624nm			85lm	26lm	<3nm	
	Green	522-528nm			220lm	67lm	<3nm	
	Blue	468-474nm			35lm	11lm	<3nm	
	2700K	2725±145K	<5SDCM	80	220lm	67lm	<2.3SDCM	82~87
C-SFR-F22E-HB-24CV-RGBW(30K)-WM-84-15W-83.3	Red	618-624nm			85lm	26lm	<3nm	
	Green	522-530nm			220lm	67lm	<3nm	
	Blue	468-474nm			35lm	11lm	<3nm	
	3000K	3045±140K	<5SDCM	80	220lm	67lm	<2.3SDCM	82~87
C-SFR-F22E-HB-24CV-RGBW(40K)-WM-84-15W-83.3	Red	618-624nm			85lm	26lm	<3nm	
	Green	522-528nm			220lm	67lm	<3nm	
	Blue	468-474nm			35lm	11lm	<3nm	
	4000K	3985±275K	<5SDCM	80	220lm	67lm	<2.3SDCM	82~87

Note:

1. CCT Tolerance refers to target CCT and tolerance (ANSI C78.377).
2. Color Tolerance refers to CLEAR standard for finished product and LED.

Max. Running Length Input: DC24V

Type	Silicone Injection-moulded Connector	
IP Rating	IP68	
Item Code	Single-end Feed	Double-end Feed
C-SFR-F22E-15W-Static full loading	8m/26.2ft	16m/52.4ft
C-SFR-F22E-15W-Dynamic operating	12m/39.4ft	24m/78.8ft
Dimension of Connector	Page F22 179	
Max.Packing Length	Page F22 233	

Note:

1. Above conclusion is based on voltage drop testing result of the light with 0.3m (0.98ft) cable only.
2. The maximum running length is based on the light in static full loading status exceptionally stated dynamic operating.
3. Above running length is only the light length excluding lengths of connectors. Please refer to the specific dimension of each connector.
4. The delivery length might be subject to the maximum packing length.

Flexglo™ F22E Wiring Diagram

1. Please use a constant voltage power supply with corresponding output voltage, and rated wattage of the power supply shall be 25% more than the actual power consumption of light to increase its life expectancy;
2. A compatible controller is required to achieve various light changing effects;
3. The rated power of controller/decoder shall be higher than the actual power consumption of light; its frequency range shall be 100~2000Hz, and 500Hz is recommended;
4. Full loading in RGBW is not recommended to avoid the overheating of light.
5. This wiring diagram is using the mains of AC230V with brown and blue wires as an example, and please connect with the corresponding live and neutral wires for other mains electricity;

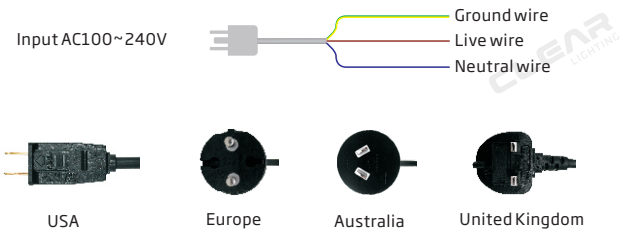

6. Types of standard plugs are optional if power cord is purchased from CLEAR.

Single-end Feed

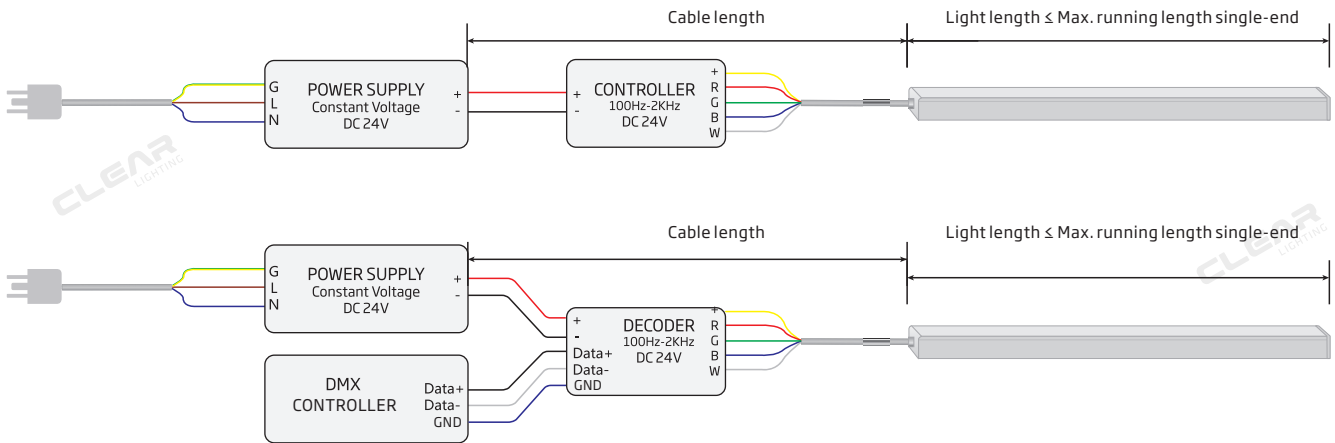

Light Length:

The length of the longest single light in parallel connection or sum of lights in series connection.

Cable Length:

The length of an electrical cable between power output end and light input end, and the cables for serial interconnection are inclusive.

How to Minimize Voltage Drop and Signal Transmission Attenuation

1. Please ensure the cable length is not more than the table "Max. Cable Length" according to light length and its wire gauge.
2. Please ensure the light length is less than the cable "Max. Running Length Single-end Feed".
3. Shielded Twisted Pair cable is required to be used to connect DMX master controller and decoder, and its length shall be less than 300m.

Max. Running Length Single-end Feed

Input: DC24V

Connector Type	Injection-moulded Connector	Dual Injection-moulded Connector
Wire Gauge	20AWG*1+22AWG*4	20AWG*1+22AWG*4
C-FR-F22E-15W-Static full loading	5m/16.4ft	5m/16.4ft
C-FR-F22E-15W-Dynamic operating	8m/26.2ft	8m/26.2ft
C-SFR-F22E-15W-Static full loading	8m/26.2ft	/
C-SFR-F22E-15W-Dynamic operating	12m/39.4ft	/

Note:

1. Above conclusion is based on voltage drop testing result of the light with 0.3m (0.98ft) cable only.
2. The maximum running length is based on the light in static full loading status exceptionally stated dynamic operating.
3. Above running length is only the light length excluding lengths of connectors.
4. The delivery length might be subject to the maximum packing length.

Double-end Feed

Please refer to the following wiring diagram with double-end feed to run length that is longer than max. running length for single-end feed but less than twice the value.

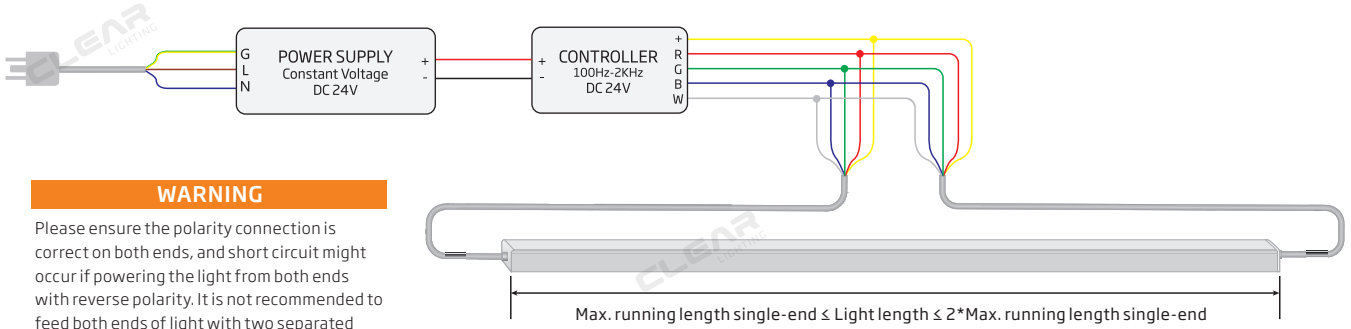

WARNING

Please ensure the polarity connection is correct on both ends, and short circuit might occur if powering the light from both ends with reverse polarity. It is not recommended to feed both ends of light with two separated power supplies, which would lead to overloading and overheating problem if either power supply is failed.

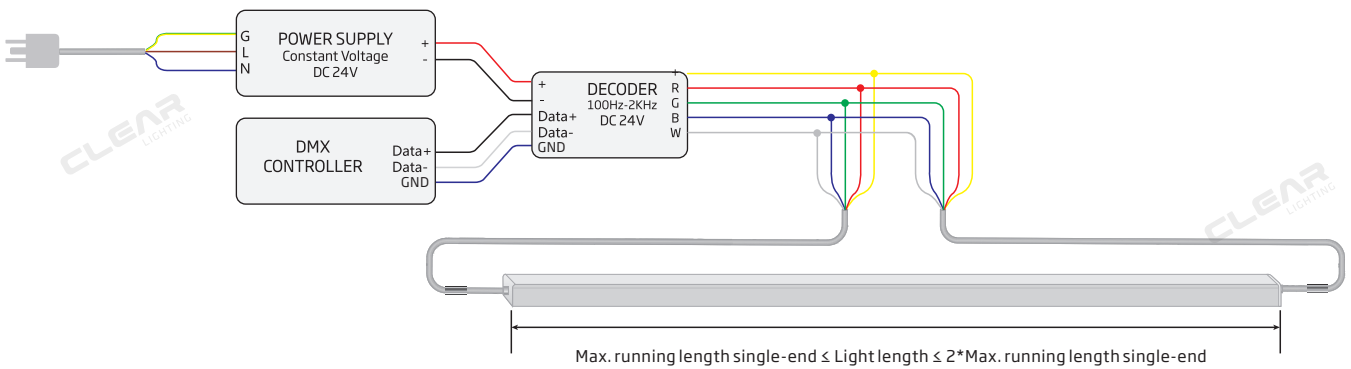

Light Length:

The length of the longest single light in parallel connection or sum of lights in series connection.

Cable Length:

The length of an electrical cable between power output end and light input end, and the cables for serial interconnection are inclusive.

How to Minimize Voltage Drop and Signal Transmission Attenuation

1. It is optimal to position the power supply in the middle of a single light or multiple lines in daisy chain to keep the equivalent cable length on both ends for double-end feed.
2. Please ensure the cable length is not more than the table "Max. Cable Length" according to the half of light length and its wire gauge.
3. Please ensure the light length is less than the table "Max. Running Length Double-end Feed".
4. Shielded Twisted Pair cable is required to be used to connect DMX master controller and decoder, and its length shall be less than 300m.

Max. Running Length Double-end Feed

Input: DC24V

Connector Type	Injection-moulded Connector	Dual Injection-moulded Connector
Wire Gauge	20AWG*1+22AWG*4	20AWG*1+22AWG*4
C-FR-F22E-15W-Static full loading	10m/32.8ft	10m/32.8ft
C-FR-F22E-15W-Dynamic operating	16m/52.5ft	16m/52.5ft
C-SFR-F22E-15W-Static full loading	16m/52.5ft	/
C-SFR-F22E-15W-Dynamic operating	24m/78.7ft	/

Note:

1. Above conclusion is based on voltage drop testing result of the light with 0.3m (0.98ft) cable only.
2. The maximum running length is based on the light in static full loading status exceptionally stated dynamic operating.
3. Above running length is only the light length excluding lengths of connectors.
4. The delivery length might be subject to the maximum packing length.

F22 Silicone Injection-moulded Connector IP68



Recommended for

1. Wet environments.
2. High-low temperature or intense humidity and UV.
3. Customized lengths.
4. Harsh working conditions or unexpected excessively external force during construction.



Feature

Precision milling and special glue Silicone liquid injection-moulded workmanship enable an almost consistent size between connectors and light body, and the transparent terminal of the connector allows the seamless effects spliced end by end.

DryWire™ technology applied on the cable eliminates the capillary phenomenon through wires, which secured the long-term reliability in outdoor or any wet environments. Light lengths can be customized on the basis of projects and pre-installation before the delivery eases the assembly trouble on site.

In-house Test

Test Object	No.	Experiment Item	Standard
Metal Parts	1	Weather Resistance- Salt Spray	IEC 68-2-11
Waterproof	1	Waterproof-IPX5 / IPX7 / IPX8	CLEAR-defined [®]
Connector	2	Swing-extreme	CLEAR-defined [®]

[®]Before waterproof test, high-low temperature cycling shock test has been implemented to simulate the outdoor harsh weather, and it's a more stringent standard we're compliant with than third party's.

Connector Type

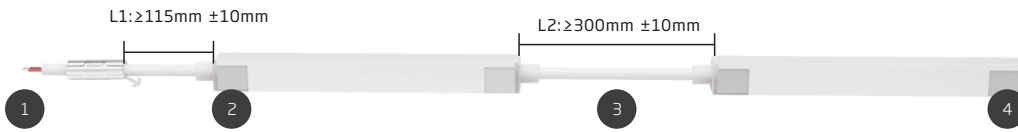

1	2	3	4
<p>Male & Female Connector (Optional)</p>  <p>Male Connector</p>  <p>Female Connector</p>	<p>Silicone Injection-moulded Front Connector</p>  <p>End</p>  <p>Side-L</p>  <p>Side-R</p>  <p>Bottom</p>	<p>Silicone Injection-moulded Middle Connector</p>  <p>Silicone Injection-moulded Jumper Maximum 8 jumpers in 20m light Maximum 4 jumpers in 10m light</p>  <p>Silicone Injection-moulded T-feed Maximum 8 T-feeds in 20m light Maximum 4 T-feeds in 10m light</p>	<p>Silicone Injection-moulded End Cap</p>  <p>End cap</p>

Dimension: mm

Silicone Injection-moulded Front Connector-End

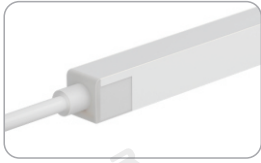

F22B/F22D/F22A/F22E/F22S-HB-SIM/FC-01/02-E
 F22B/F22D/F22A/F22E/F22S-VB-SIM/FC-01/02-E

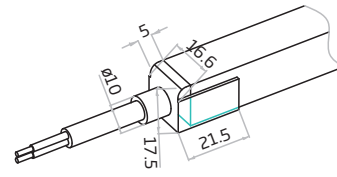

Silicone Injection-moulded Front Connector-Side

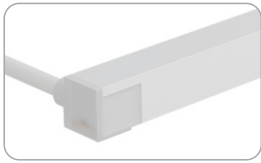

F22B/F22D/F22A/F22E/F22S-HB-SIM/FC-02-SL
 F22B/F22D/F22A/F22E/F22S-VB-SIM/FC-01/02-SL

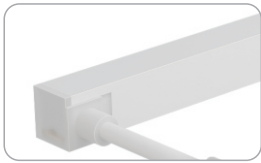
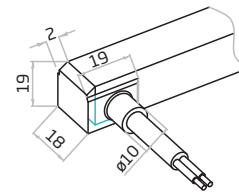

F22B/F22D/F22A/F22E/F22S-HB-SIM/FC-01-SR
 F22B/F22D/F22A/F22E/F22S-VB-SIM/FC-01/02-SR

Silicone Injection-moulded Front Connector-Bottom



F22B/F22D/F22A/F22E/F22S-HB-SIM/FC-01/02-B
 F22B/F22D/F22A/F22E/F22S-VB-SIM/FC-01/02-B

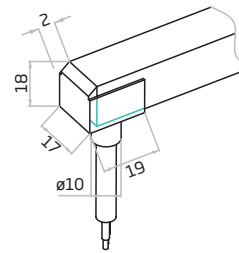

Silicone Injection-moulded End Cap

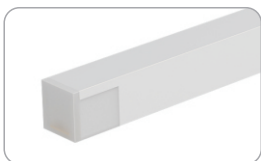

F22-SIM/EC

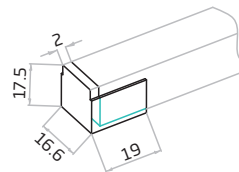

Silicone Injection-moulded Middle Connector & Power T-feed



F22B/F22D/F22S-HB-SIM/MC-PTF
 F22B/F22D/F22S-VB-SIM/MC-PTF
 L1 and L2 available in 300mm.
 L3 available in 300mm/1000mm/3000mm.

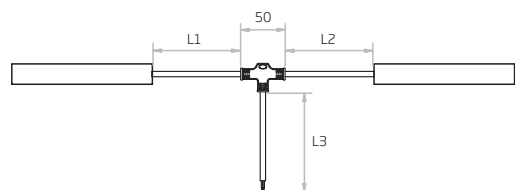

Note:

1. Unless otherwise stated, the tolerance of the connector is $\pm 0.5\text{mm}$;
2. To avoid damage from the excessive force on cable joint, please keep at least 60mm of cable ahead in the natural state.

Anti-wicking Ferrule

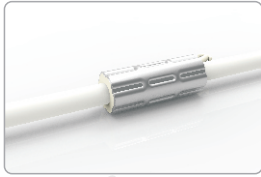

The anti-wicking ferrule is designed to lower the risk of water ingress from the cable in case of inadequate waterproof treatment on site.

For underwater application, do not immerse anti-wicking ferrule in the water.

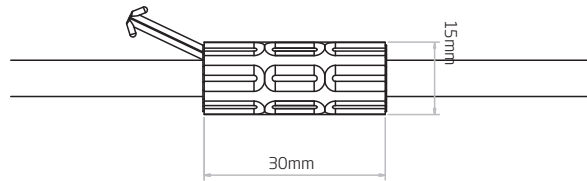
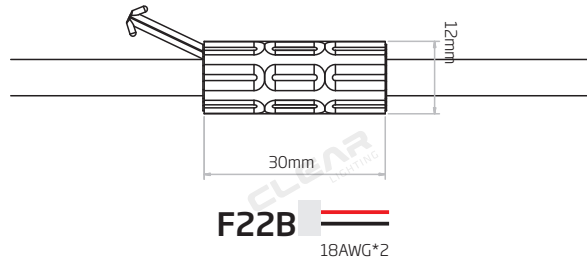

Note:

1. Unless otherwise stated, the tolerance is $\pm 0.5\text{mm}$.
2. The removal of anti-wicking ferrule will void the warranty if any water ingress caused by it.

Male & Female Connector



For plug and play cable junction, IP67

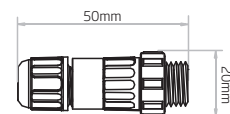

Note:

Unless otherwise stated, the tolerance is $\pm 2\text{mm}$.

F22 Serrated Aluminum Profile

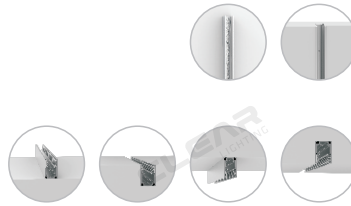

Specialized for the LED Flex Linear light, it was developed by combining the advantages of 6063 aluminum and elastic serrated tape. The inside elastic serrated tape as the grabbing force to keep continuous strong clamping force on the light body and protect the light from the damage caused by the large friction in the process of installation and dismantlement.

Please refer to the applicable installation ways.

Test Object	No.	Experiment Item	Standard
Metal Parts	1	Weather Resistance-Salt Spray	IEC 68-2-11
Mounting profile	2	Clamping force	CLEAR-defined

Dimension: mm

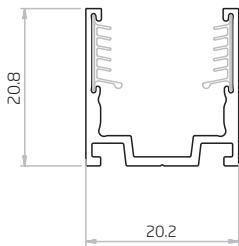

Tolerance: $\pm 0.3\text{mm}$

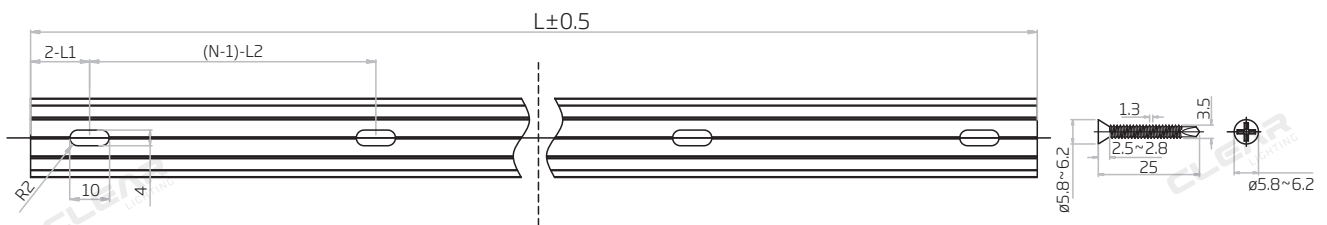
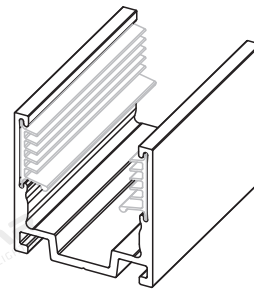

Note:

- 2-L1 refers to two of symmetric L1 in each piece of profile.
 - (N-1)-L2 refers to (N minus one) of symmetric L2 in each piece of profile.
- "N" hereby stands for its corresponding "Hole Number" in the below table

Item Code	Standard Length	L1	L2	Slotted Hole	Hole Number
F22-SA/PL-20MM-AL	20mm/0.787in	10mm/0.39in	/	4*10mm/0.16*0.39in	1
F22-SA/PL-500MM-AL	500mm/19.68in	50mm/1.97in	200mm/7.87in	4*10mm/0.16*0.39in	3
F22-SA/PL-1000MM-AL	1000mm/39.37in	100mm/3.93in	200mm/7.87in	4*10mm/0.16*0.39in	5
F22-SA/PL-2000MM-AL	2000mm/78.74in	100mm/3.93in	200mm/7.87in	4*10mm/0.16*0.39in	10