

Sculpt The Multifaceted Beauty Like A Diamond

Brighten the space in an all-around display with the modern led lights.

Three-side Emitting Stylish Neon flex



It's derived from our regular silicone neon flex but with three-side emitting sides prevailing in sculptures, façades, and escalators where commonly used as surface mounted linear lighting or linear pendant lighting beyond the indoor environments.

In light of multiple frosted LED diffusers, it displays a frontal impressive visual experience coupled with two more viewing angles on the sides to expand the illuminated areas to the fullest. No matter which side, the modern neon flex always offers a consistent and even lighting color. The powerful shaping ability and the jade-like texture greatly broaden the boundary in the aesthetics and functionality of the modern linear flex light.

Features

★ Three-side emitting surfaces

Only with the three-side emitting surfaces, this neon flex offers you a spectacular 360° view of the surroundings when mounted on the object. It's enough to cover the entire illumination range for scenarios such as façades or the curved edge on escalators.

★ High Brightness

By adopting frosted transmitting silicone materials, its lateral light leakage is successfully decreased and leads to a higher lumen output up to 1100lm/m.

★ Soft and Dot-free Illumination

The diffuse reflection enables the glow mixed inside to be even and friendly on the eyes. The increased emitting surfaces will not compromise on the consistent lighting effect.

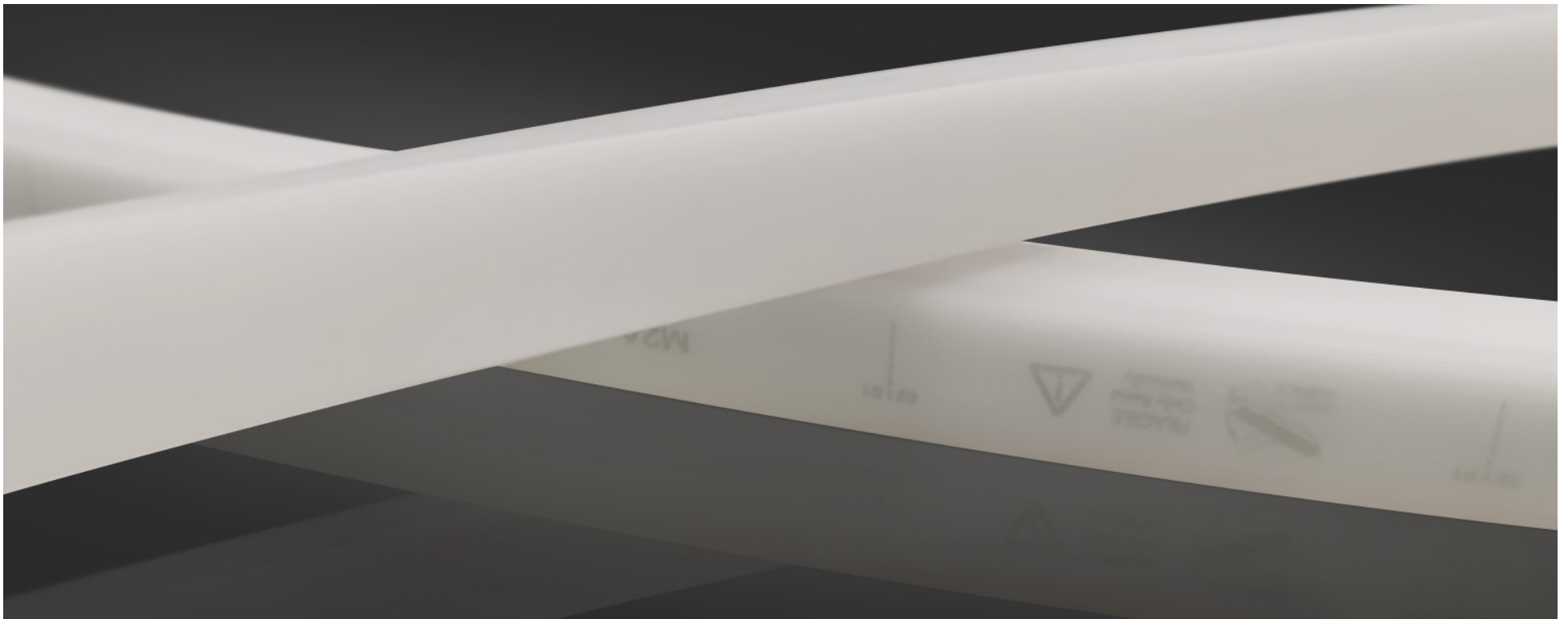

Article No.	SFR-F22BT-VB	SFR-F22DT-VB	SFR-F22AT-VB	SFR-F22ET-VB
Light Color	2200K/2700K/3000K 3500K/4000K/5700K 	2200K~5700K 	RGB 	RGBW 
Voltage & Circuit Type	24CC	24CV	24CV	24CV
Power/m	12W	12W	12W	15W
Lumen/m	>1100lm@3000K	>400lm@5700K	>545lm@R+G+B	>300lm@RGBW(3000K)
Min. Cutting Length(mm)	55.6	83.3	83.3	83.3
Max. Running Length(m) -Swivel Connector	5	/	/	/
Max. Running Length(m) -Snap Connector	15	15	/	/
Max. Running Length(m) -Socket Connector	15	/	/	/
Max. Running Length(m) -Silicone Injection-moulded Connector	15	15	10	8

Vertical
Bending

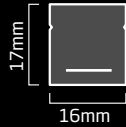

Connector

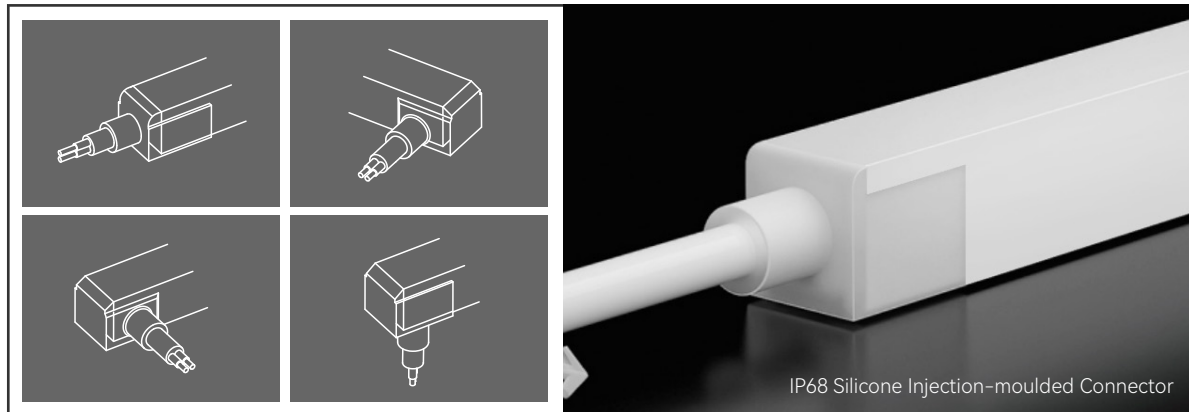
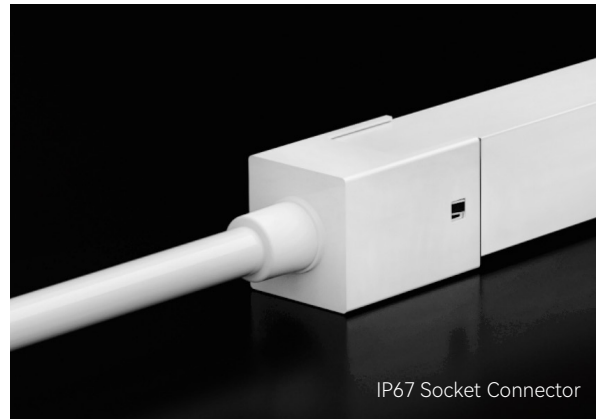
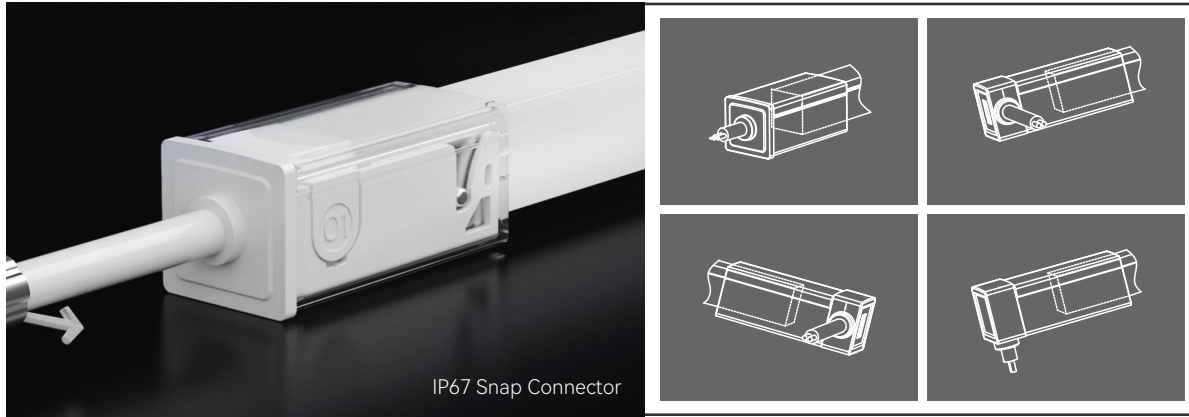

Mounting Profile

Name	Hybrid Profile
Picture	
Item Code	F22-H/PL
Length(mm)	35, 500, 1000, 2000
Application	

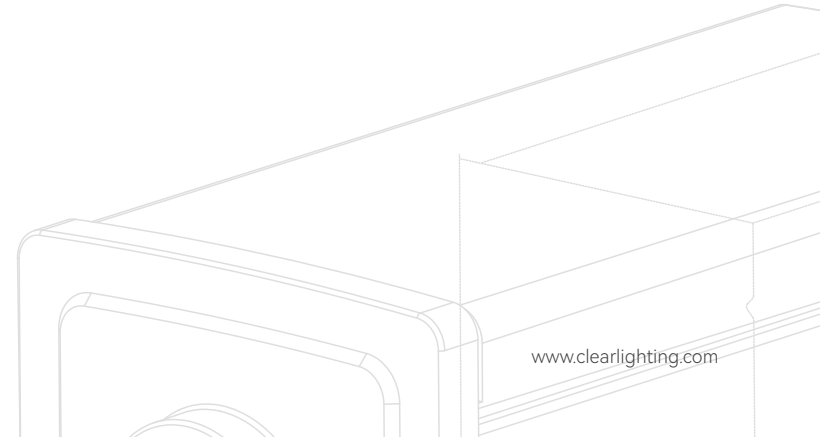

Application

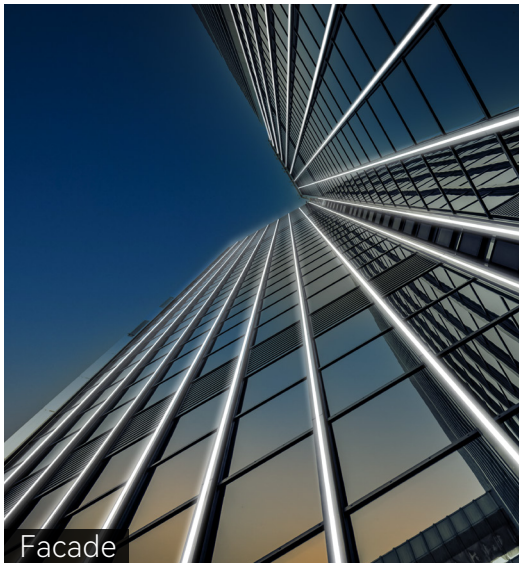

Facade

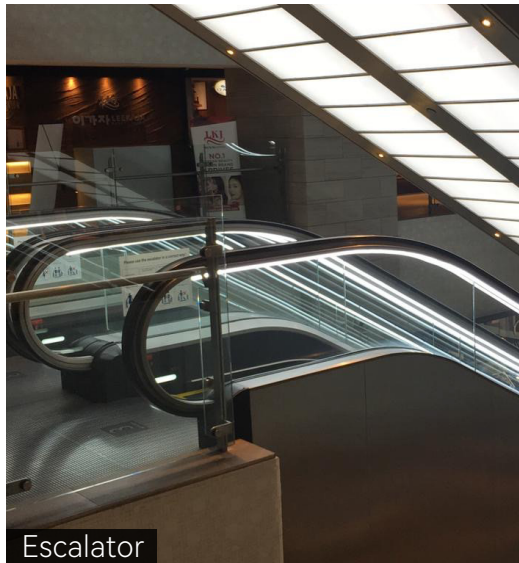

Escalator

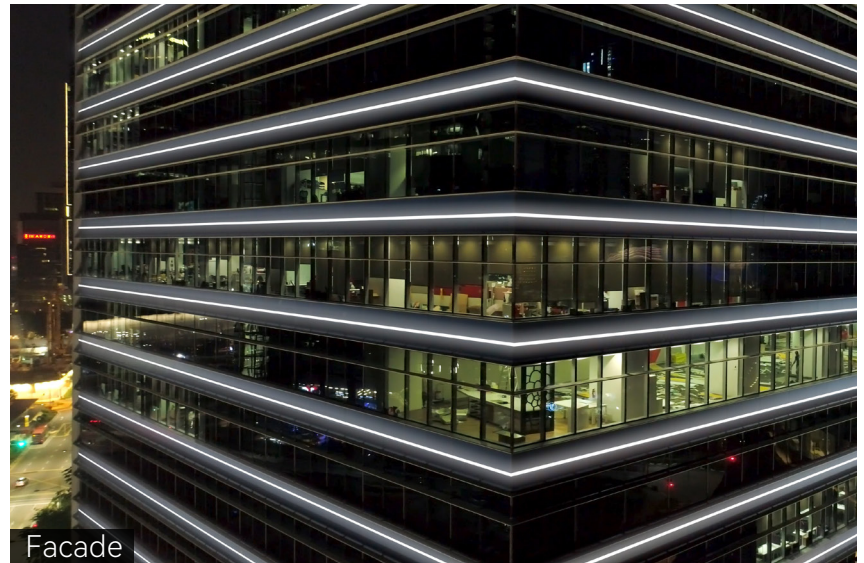

Facade



Gallery



Showroom

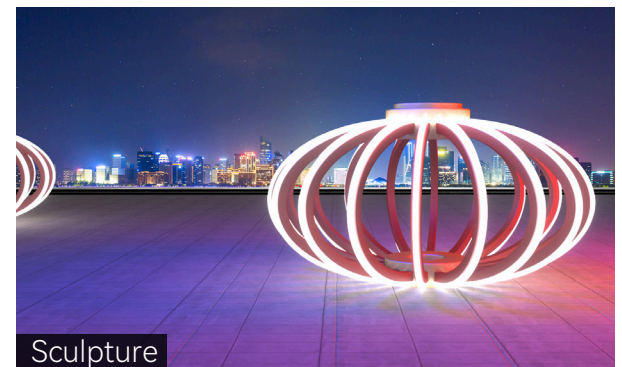

Sculpture